



Ultrawood

DÉCORATION D'INTÉRIEUR EN LDF

2020



Ultrawood

DÉCORATION D'INTÉRIEUR EN LDF

Harmonie de l'espace et de l'environnement.

Table des matières

ÉCOLOGIE	6
LA MARQUE	8
DÉCORATION EN LDF DANS L'AMÉNAGEMENT D'INTÉRIEUR	10
DIMENSIONS	16
PLINTHES	28
CORNICHES	46
CHAMBRANLES	62
CIMAISES	70
PROFILS	86
PANNEAUX MURAUX	94
ÉLÉMENTS DÉCORATIFS	100
ÉLÉMENTS APPARIÉS	108
INSTALLATION	110
AMBIANCE COLORÉE	112
PARTENARIAT	116
COLLE	118



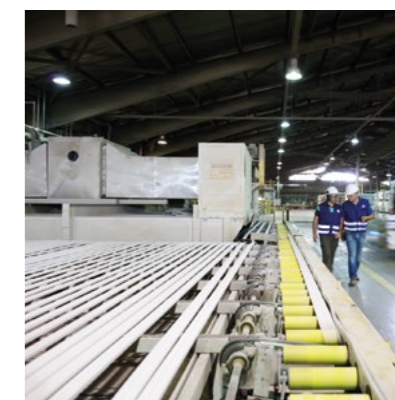
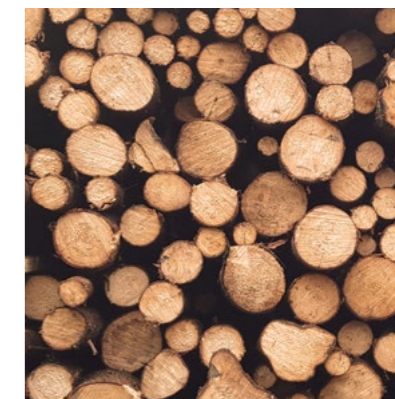

- **Matériaux écologiques :** La décoration en LDF Ultrawood est fabriqué dans l'Amérique du Sud. L'utilisation d'arbres sauvages pour la fabrication de produits Ultrawood est interdite.

- **Écologie et environnement :** les matières premières sont achetées dans un rayon de 100 miles du lieu de transformation.

- **Matériau homogène :** pour nos produits nous utilisons exclusivement le pin de la variété Radiata cultivé dans des plantations renouvelables d'une superficie de plus de 5 000 000 d'hectares.





Décoration en LDF Ultrawood pour votre aménagement d'intérieure

DESIGN.

Tous les profils peuvent être combinés entre eux pour créer de nouvelles formes. Une large gamme de produits vous permettra de trouver des profils pour un style classique ou moderne.

SÉCURITÉ.

Nos produits sont fabriqués à partir de matériaux naturels. Fibre de bois pressée avec apprêt à base de craie.

QUALITÉ GARANTIE.

Les profils en LDF Ultrawood sont durables, résistants aux chocs, prêts pour la peinture, avec une géométrie parfaite.



- Décoration d'intérieur LDF Ultrawood peut être utilisée pour la décoration des murs, des plafonds et des meubles
- Ultrawood est un jeu de construction: les profils peuvent être combinés les uns avec les autres pour un design créatif.

- Les corniches CR 2390 ont été utilisées pour encadrer une gaine de climatiseur cachée. Cela a permis de mettre cette spécificité de la pièce à son avantage. Les fixations des rideaux sont cachées derrière la corniche.

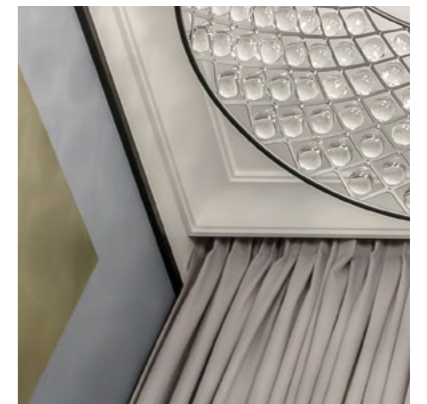
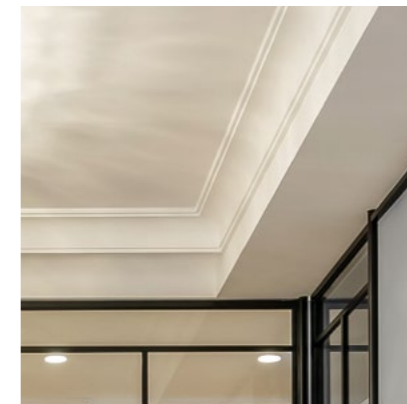

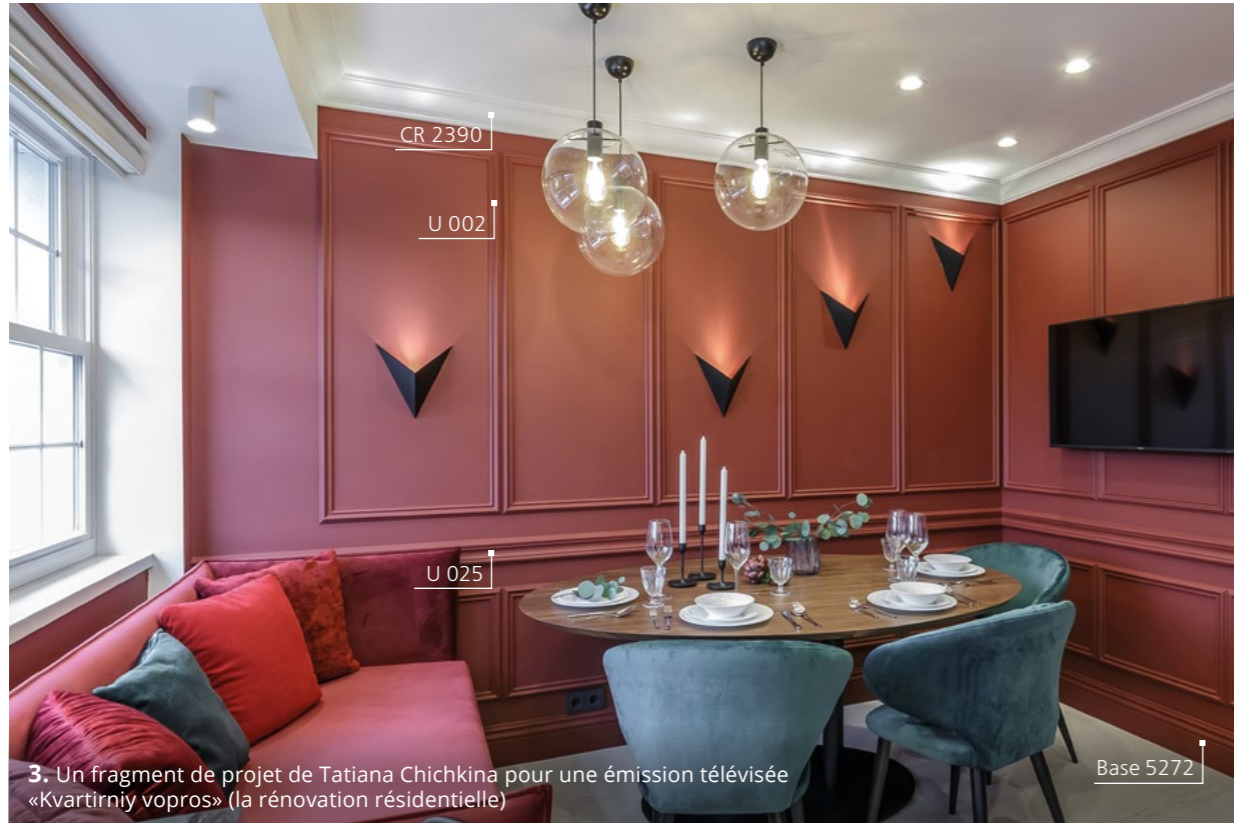

- Sur la photo 4 la corniche CR 001 est utilisée :
 - pour décoration des caissons ;
 - comme un capitole décorant une colonne de support.





6.







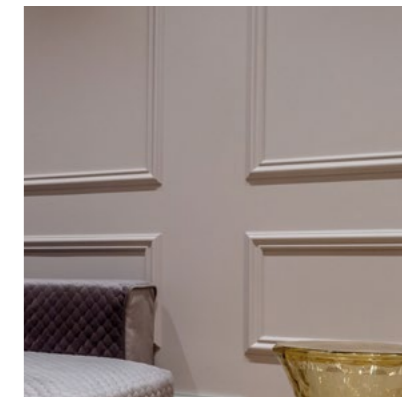



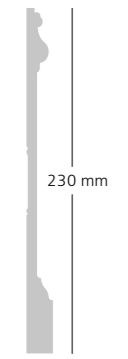
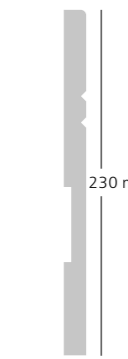
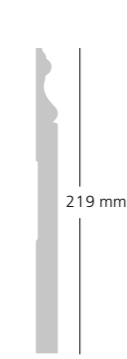
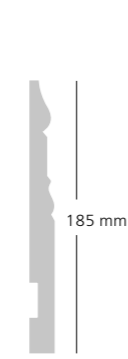
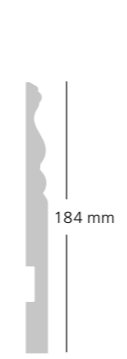
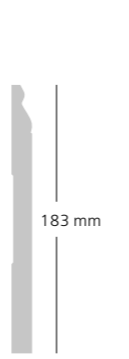
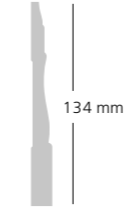
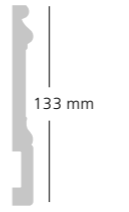
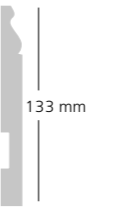

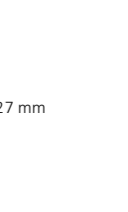
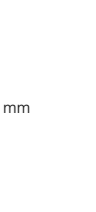









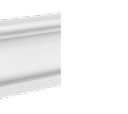

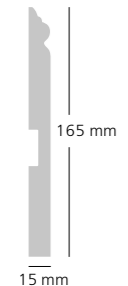
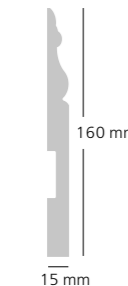

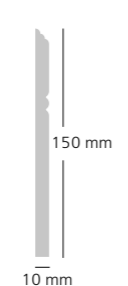
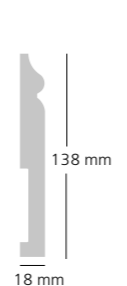
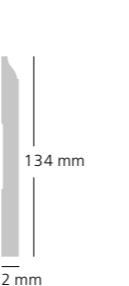
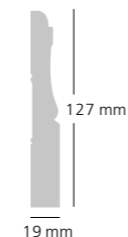
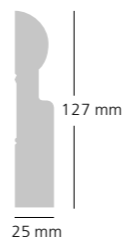
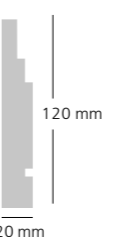
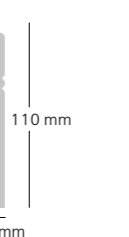





7. Un fragment de projet de Dmitri Litvinov, pour une émission télévisée «Dachnyi otvet» (rénovation de maisons)

- L'intérieur moderne avec des éléments Art déco peut être créé avec le profil E2E 9988 (photo 6).
- La cimaise U 002 pour donner un esprit classique à la pièce (photo 7).



Plinthes (p. 28-43)

 230 mm 20 mm	 230 mm 15 mm	 219 mm 15 mm	 185 mm 18 mm	 184 mm 15 mm	 183 mm 14 mm	 134 mm 15 mm	 133 mm 14 mm	 133 mm 15 mm	 133 mm 12 mm	 127 mm 17 mm	 127 mm 15 mm
	 NOUVEAU										
Base 5800 p. 41	Base 5902 p. 41	Base 005 p. 30	Base 004 p. 29	Base 5074 p. 38	Base 007 p. 30	Base 003 p. 29	Base 002 p. 29	Base 5763 p. 40	Base 5214 p. 38	Base 5573 p. 40	Base 5270 p. 38
 165 mm 15 mm	 160 mm 15 mm	 150 mm 15 mm	 150 mm 10 mm	 138 mm 18 mm	 134 mm 12 mm	 127 mm 19 mm	 127 mm 25 mm	 120 mm 20 mm	 110 mm 10 mm	 110 mm 25 mm	 102 mm 19 mm
		 NOUVEAU	 NOUVEAU								
Base 5011 p. 37	Base 5272 p. 39	Base 5901 p. 41	Base 5381 p. 39	Base 5500 p. 40	Base 008 p. 30	Base 015 p. 35	Base 010 p. 31	Base 006 p. 30	Base 5380 p. 39	Base 012 p. 31	Base 5032 p. 37

Plinthes (p. 28-43)

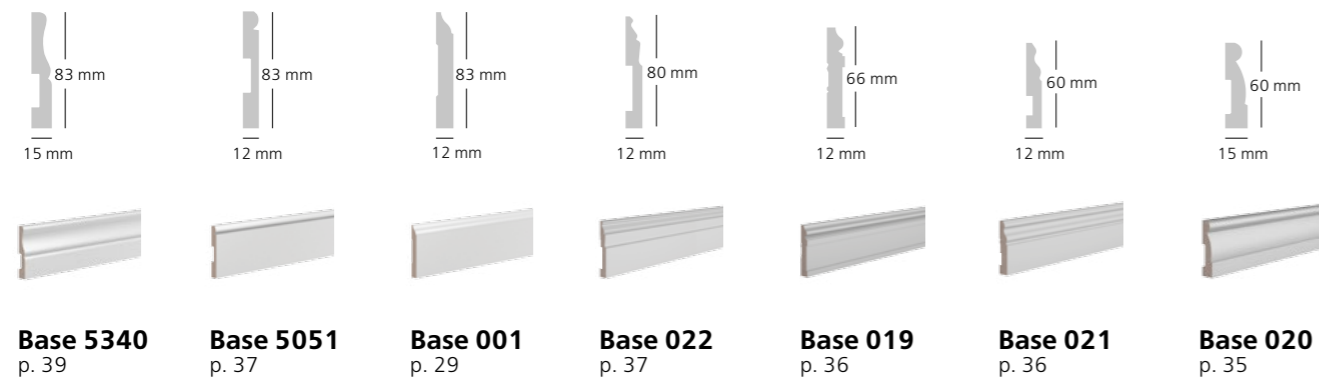
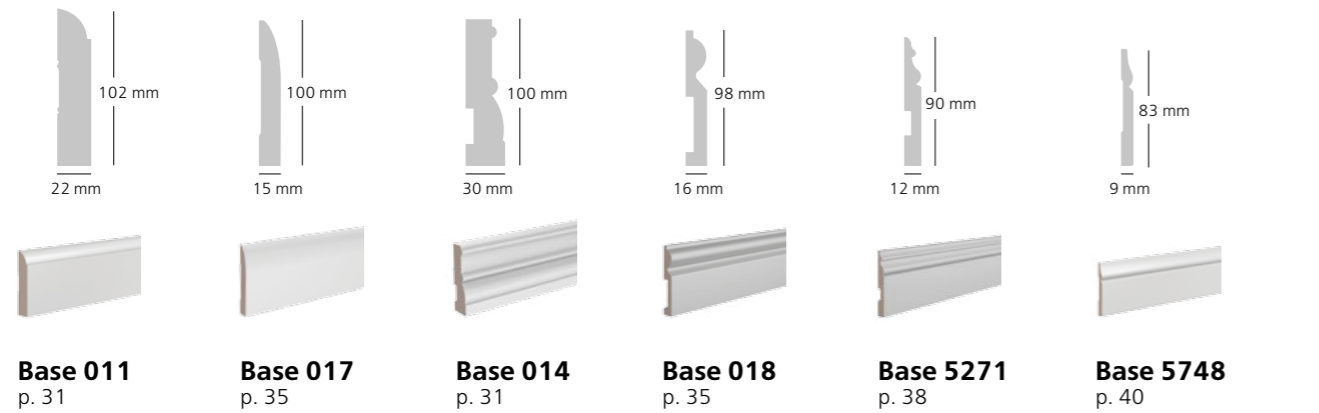

Chambranles (p. 62-69)

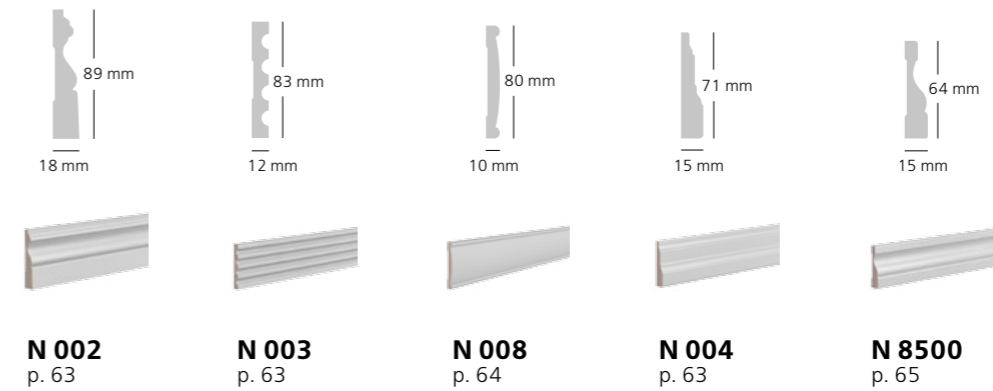
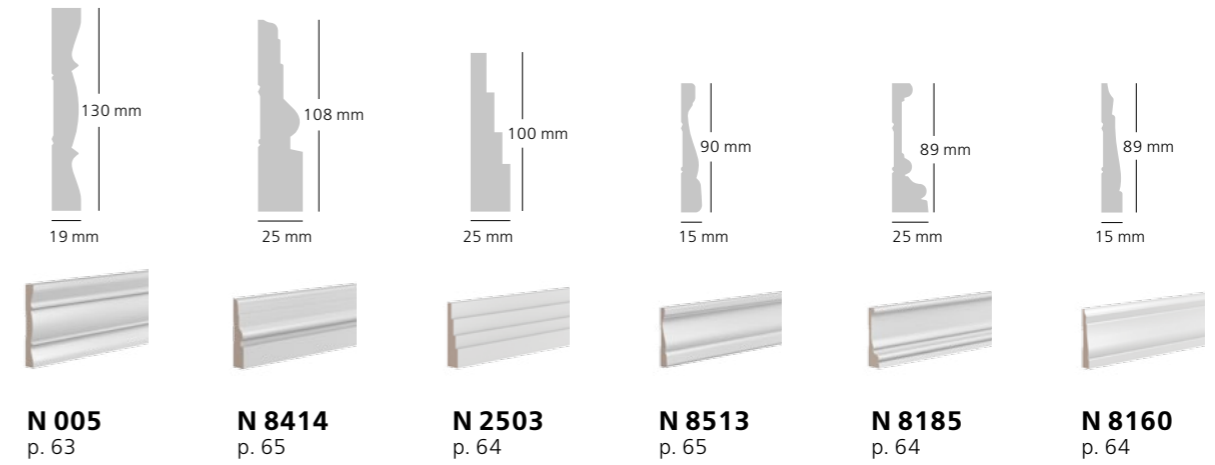

Corniches (p. 46-61)

CR 022 p. 50	CR 003 p. 47	CR 023 p. 50	CR 2335 p. 51	CR 2390 p. 51	CR 002 p. 47	CR 4258 p. 52	CR 015 p. 48	CR 021 p. 49	CR 012 p. 47	CR 017 p. 48	CR 019 p. 49
CR 001 p. 47	CR 020 p. 49	CR 018 p. 49	CR 016 p. 48	CR 4174 p. 52	CR 4080 p. 51	CR 025 p. 50	CR 014 p. 48				

Cimaises (p. 70-85)

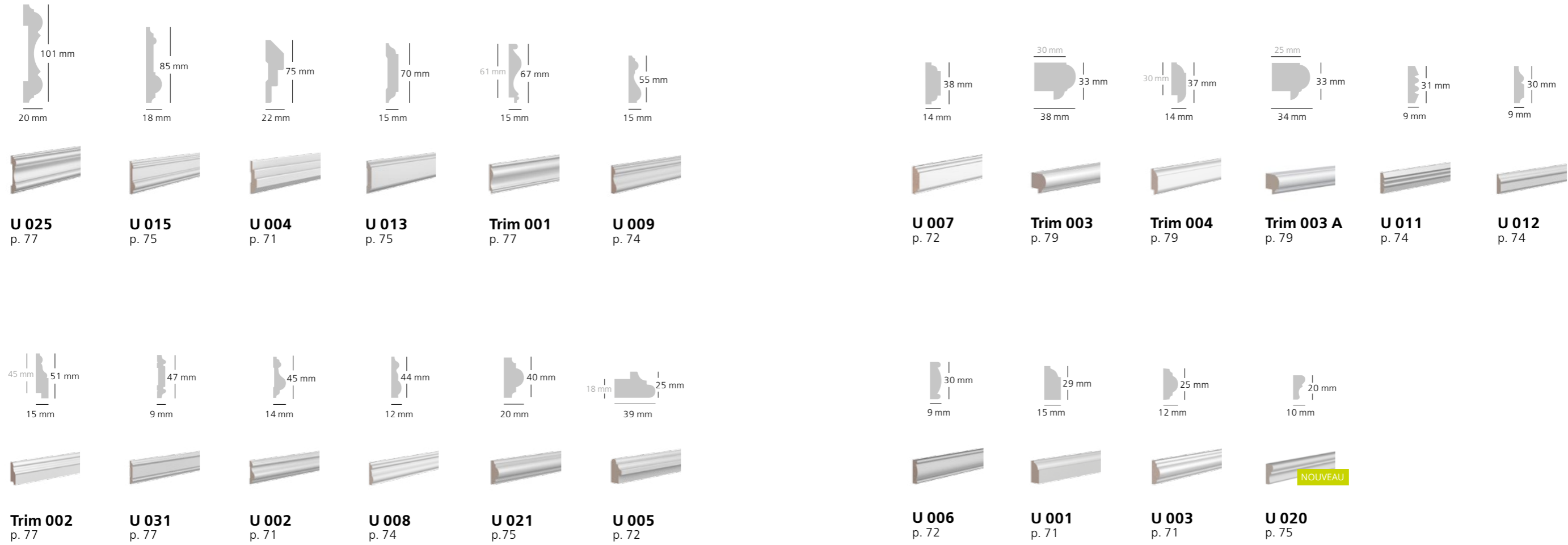

Profils (p. 86-93)

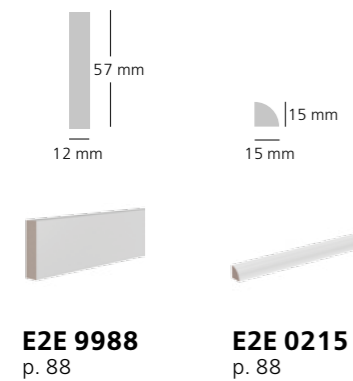
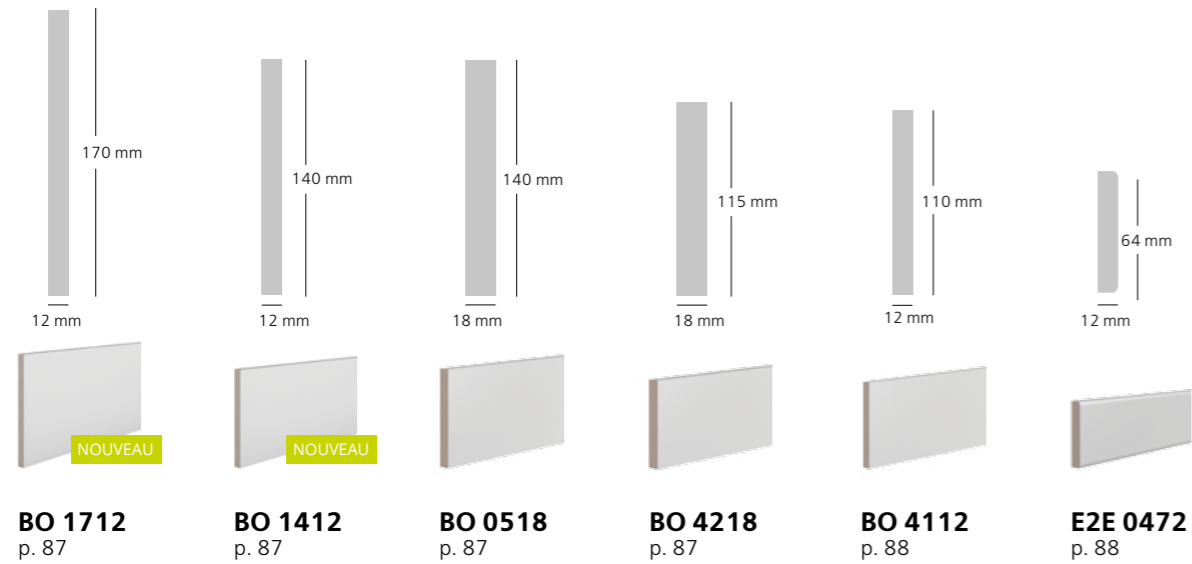

Panneaux muraux (p. 94-99)

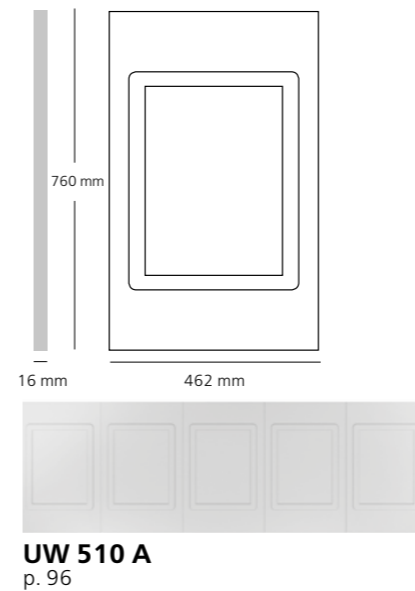
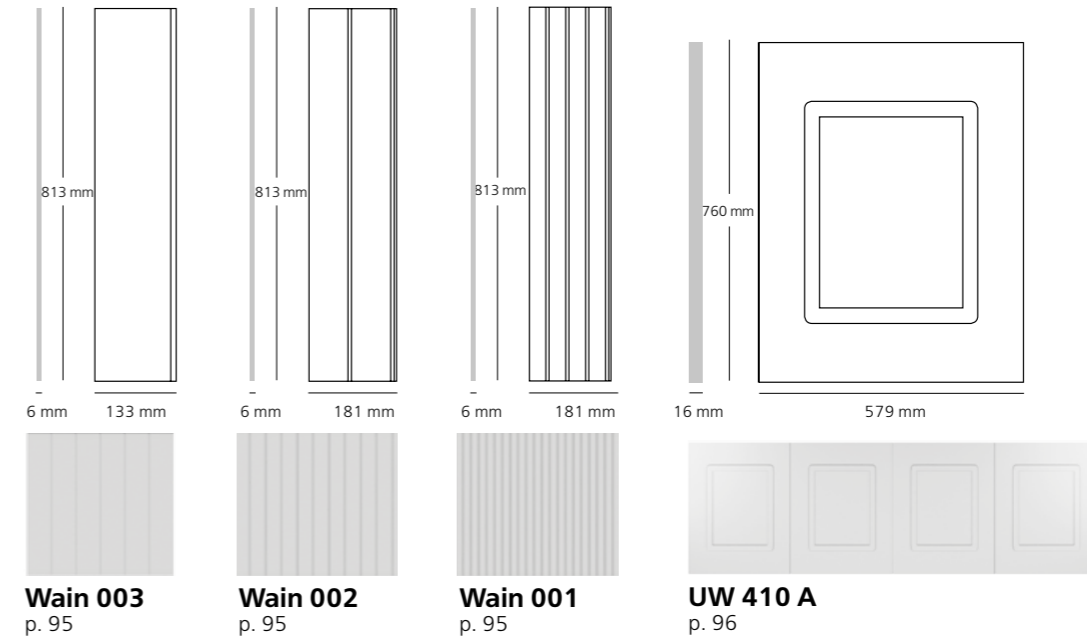

Elements décoratifs (p. 100-107)

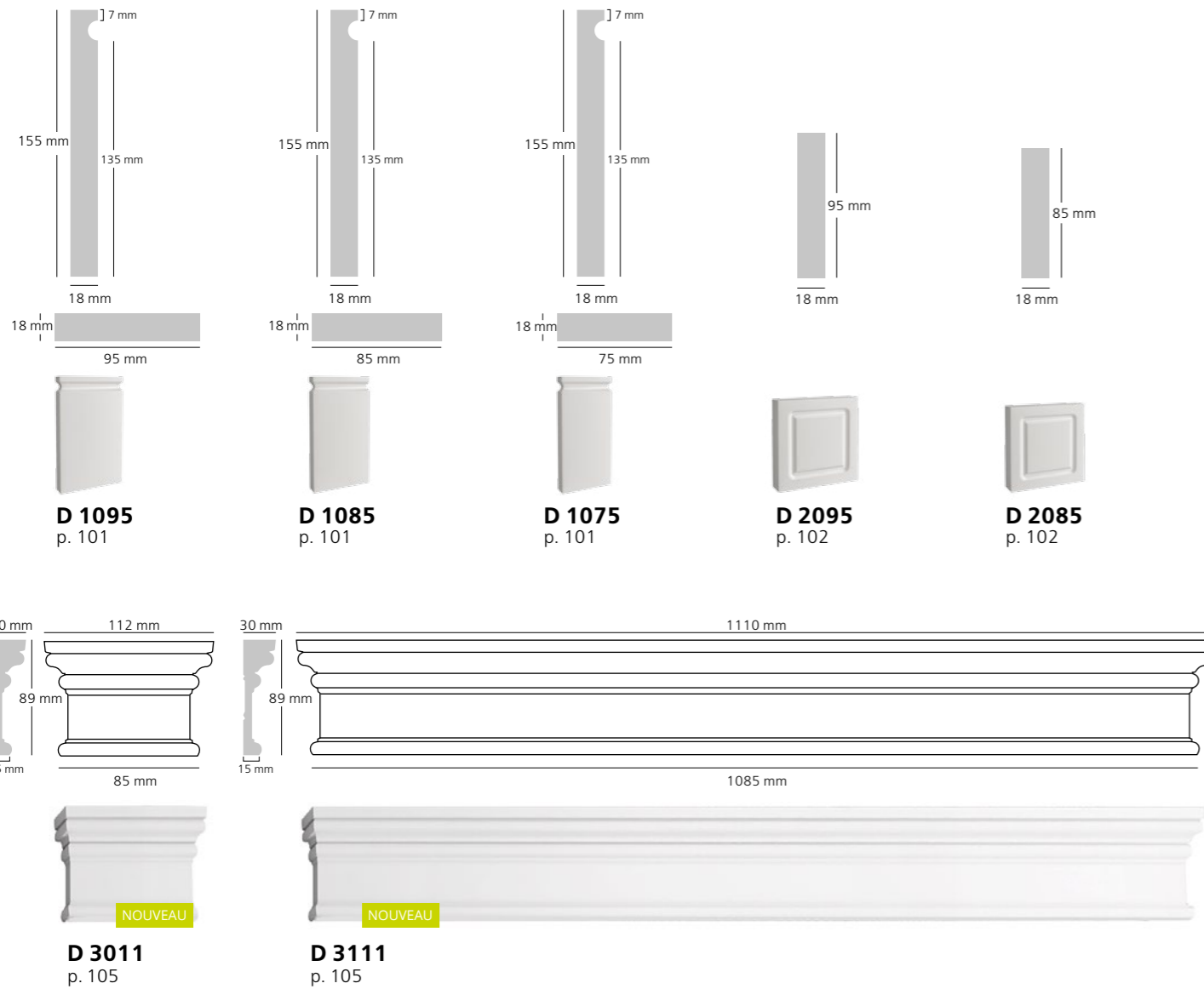

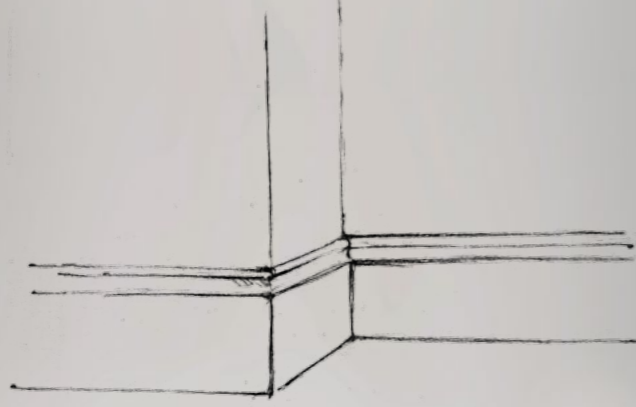

PLINTHES



La longueur de tous les profils est de 2440 mm

BEST-SELLER BASE 001



Dimensions • 83 x 12 mm

BASE 002



Dimensions • 133 x 14 mm

BASE 003

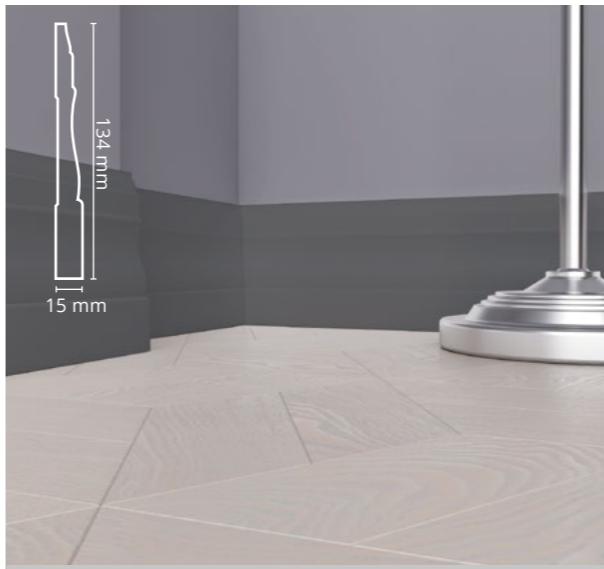

Dimensions • 134 x 15 mm

BASE 004



Dimensions • 185 x 18 mm

BASE 005



BASE 006



BASE 010



BASE 011



BASE 007



BASE 008



BASE 012



BASE 014



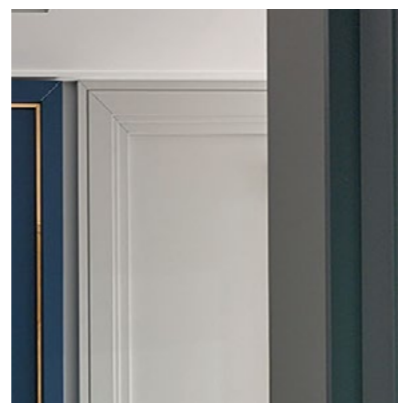

- Sur les photos 8 et 9 le profil Base 006 est utilisé :
 - en tant qu'une plinthe
 - comme un chambranle
 - et comme une cimaise pour former un cadre.





- Sur la photo 10 les profils Base 017 sont utilisés pour former des panneaux décoratifs.

BASE 015



BASE 018

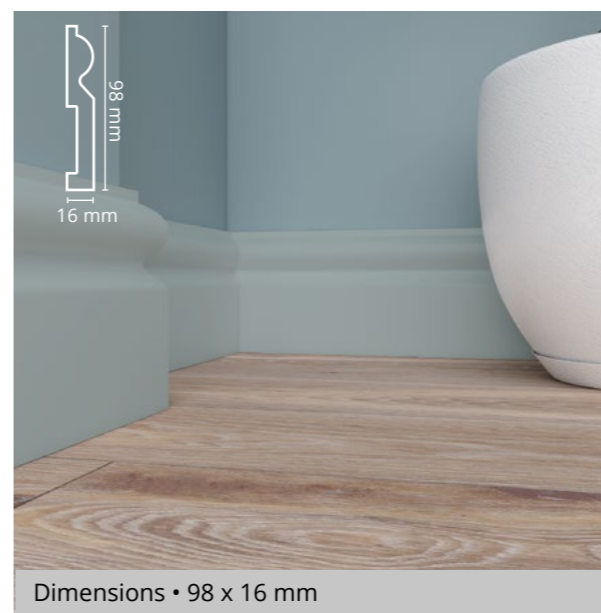

BASE 017



BASE 020

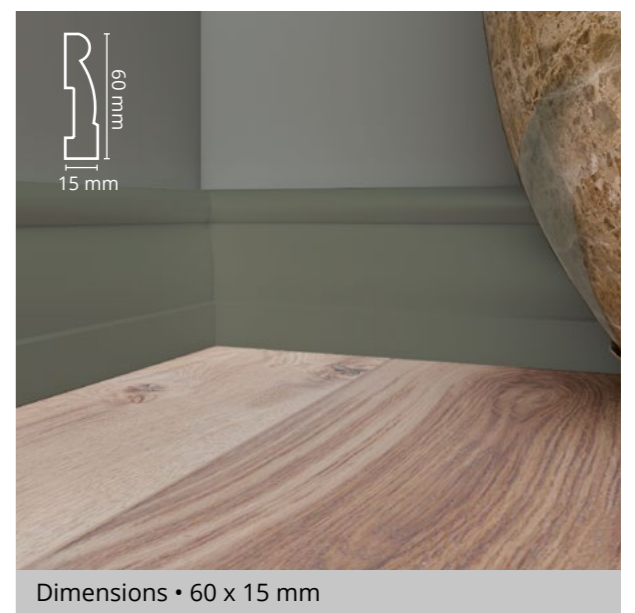

BASE 019

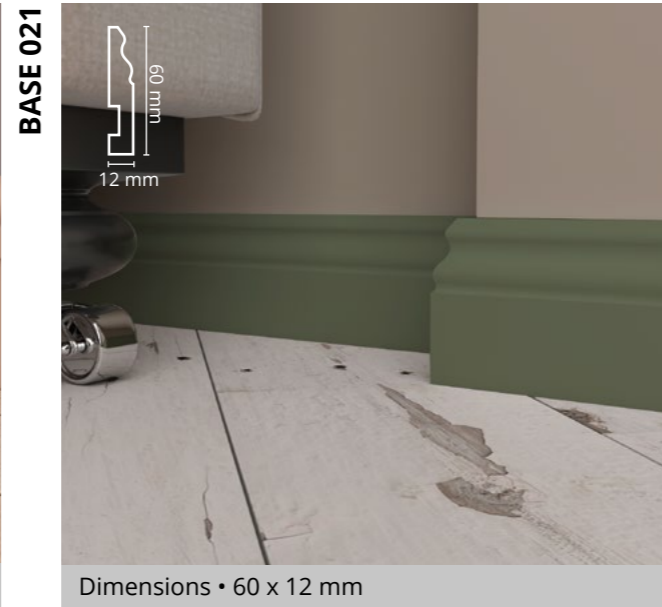

BASE 022



BASE 5011

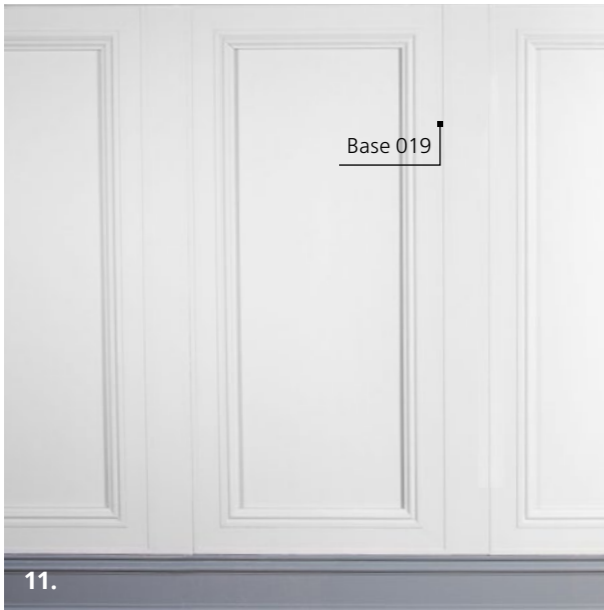

- Tous nos plinthes Base peuvent également être utilisées pour décorer des murs et des plafonds.

BEST-SELLER **BASE 5032**

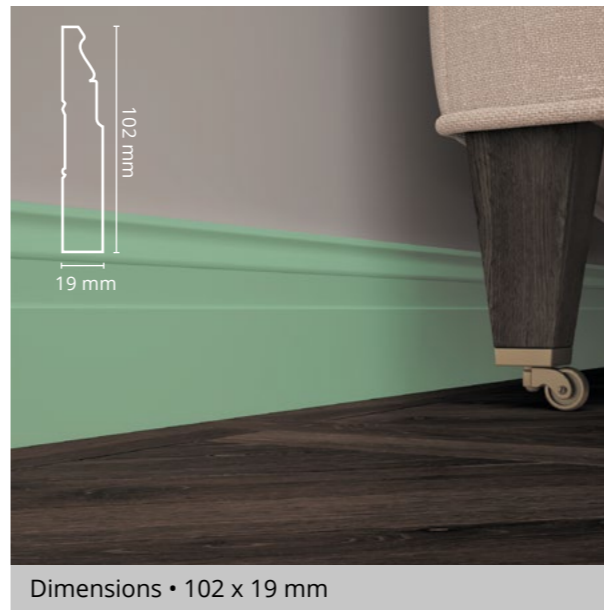

BASE 5051

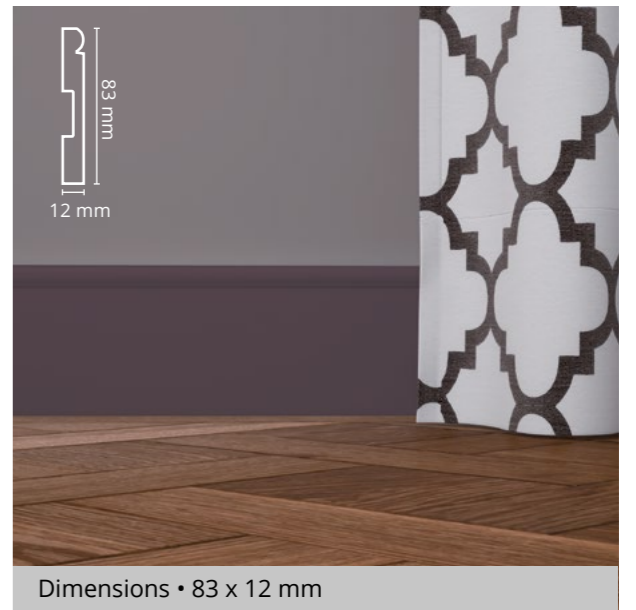

BASE 5214



Dimensions • 133 x 12 mm

BASE 5074



Dimensions • 184 x 15 mm

BASE 5272



Dimensions • 160 x 15 mm

BASE 5340



Dimensions • 83 x 15 mm

BEST-SELLER **BASE 5270**

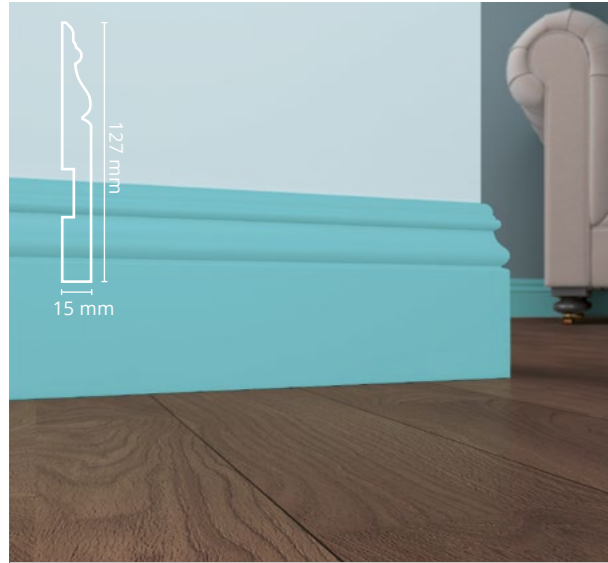

Dimensions • 127 x 15 mm

BASE 5271

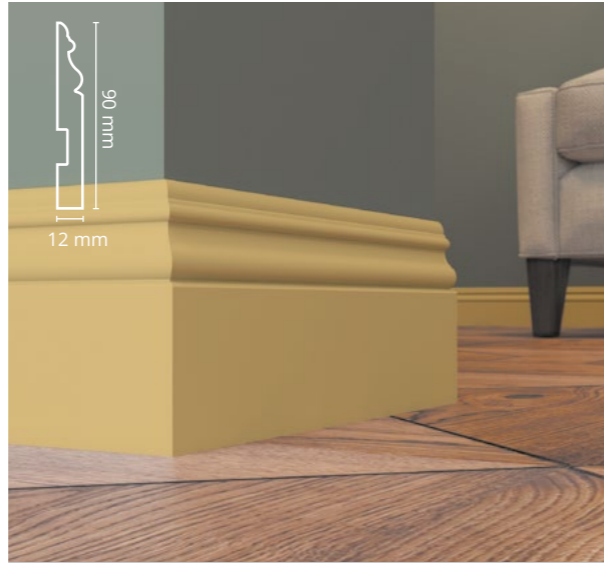

Dimensions • 90 x 12 mm

BEST-SELLER **BASE 5380**



Dimensions • 110 x 10 mm

NOUVEAU **BASE 5381**

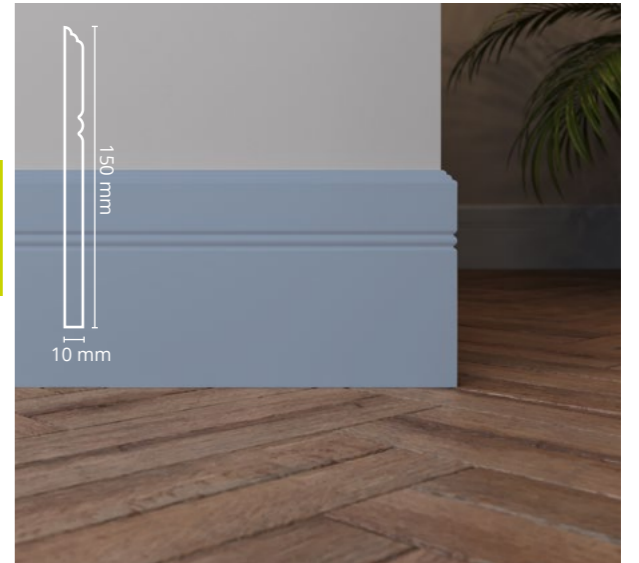

Dimensions • 150 x 10 mm

BASE 5500

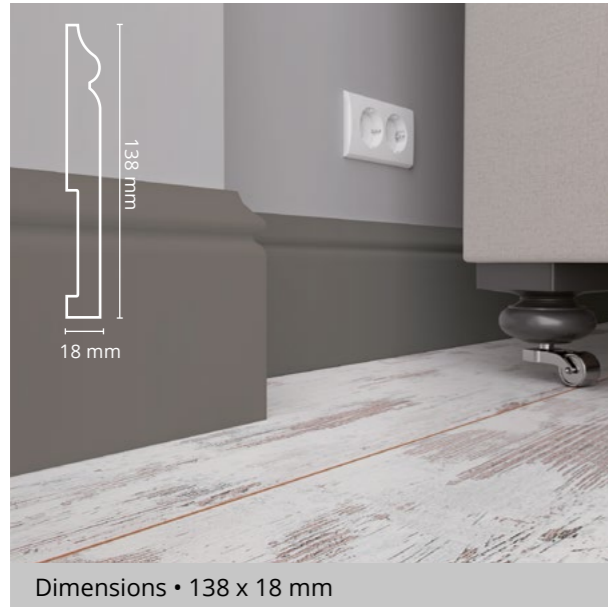

BASE 5573



BASE 5800

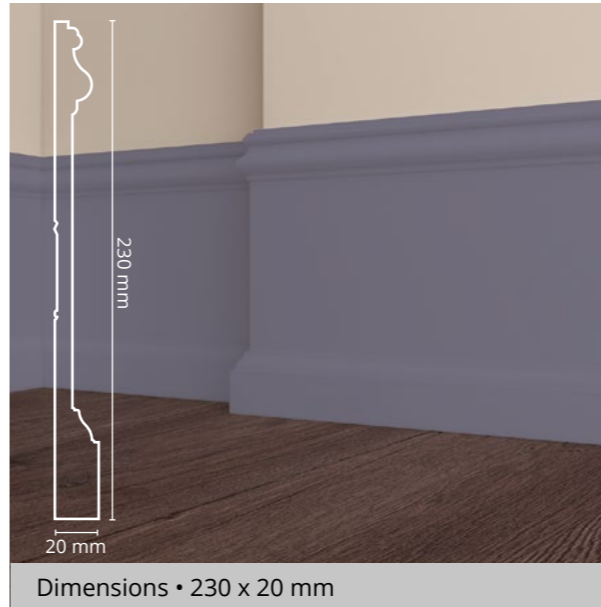

NOUVEAU **BASE 5901**



BASE 5748



BEST-SELLER **BASE 5763**



NOUVEAU **BASE 5902**



IDÉES DÉCO AVEC LES PLINTHES

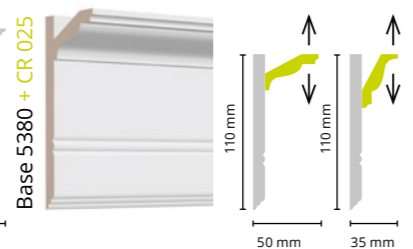
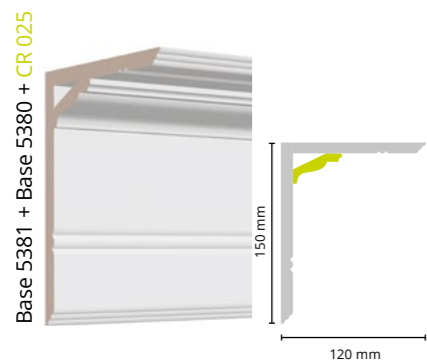
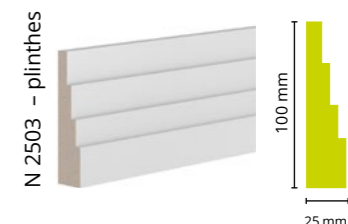
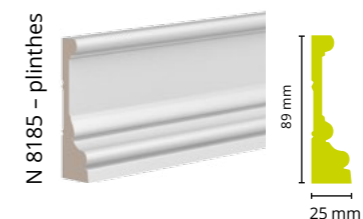
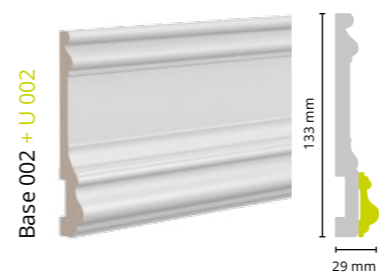
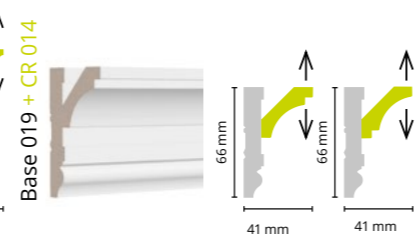
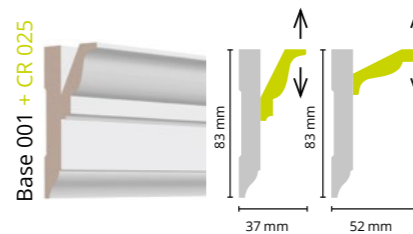
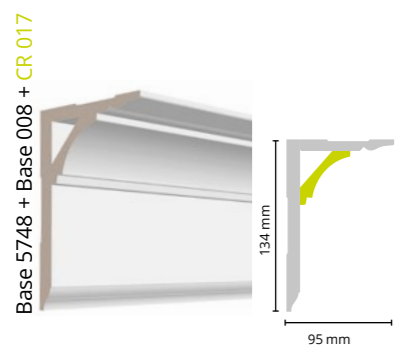
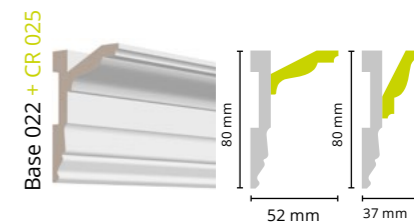
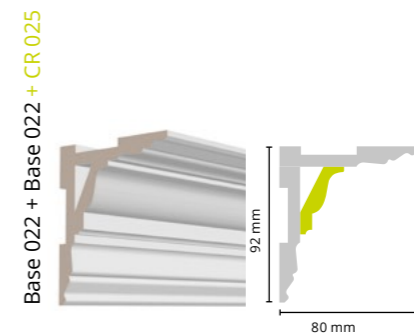
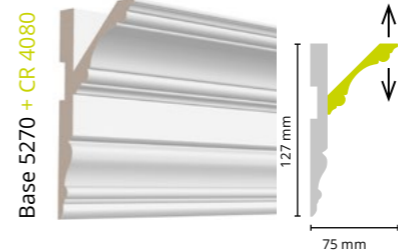
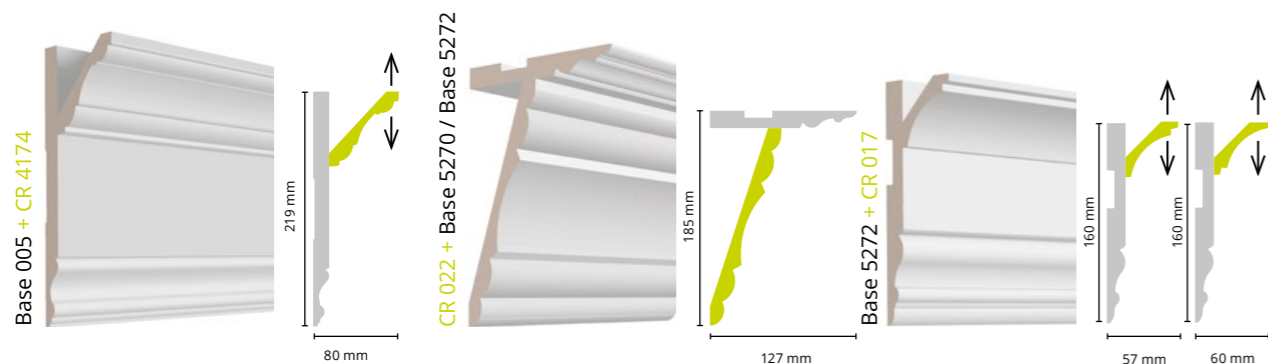

- Essayez de retourner cette composition pour un tout nouveau design.



- Les chambranles peuvent aussi être posés comme les plinthes.

IDÉES DÉCO AVEC LES PLINTHES

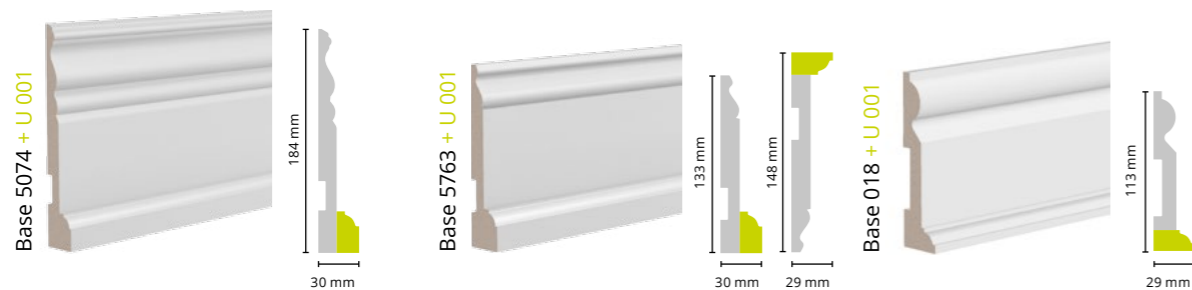

- La plinthe la plus haute Base 5902 peut être rehaussé avec une cimaise U 001.
- Le profil E2E 0215 et la cimaise U 001 en combinaison avec n'importe quelle plinthe Base peuvent être utilisées pour combler l'écart entre le mur et le sol.

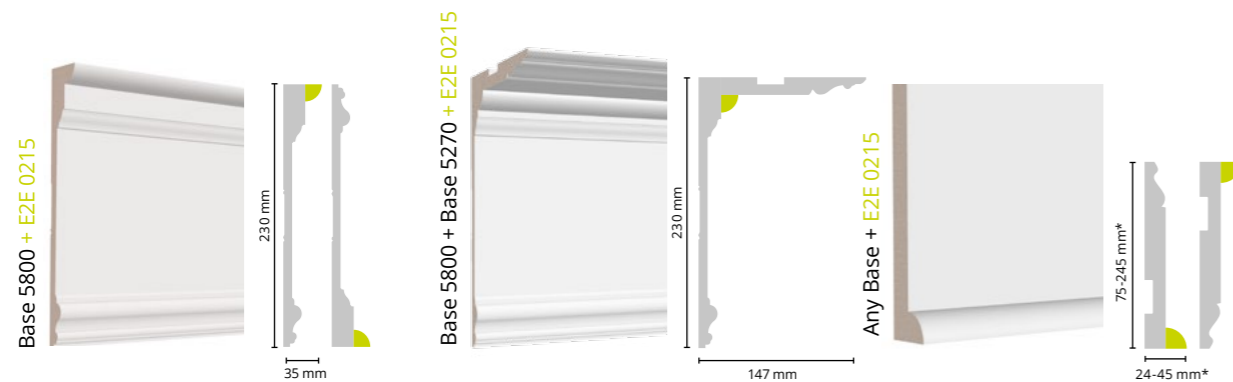

* (en fonction de la plinthe choisie)

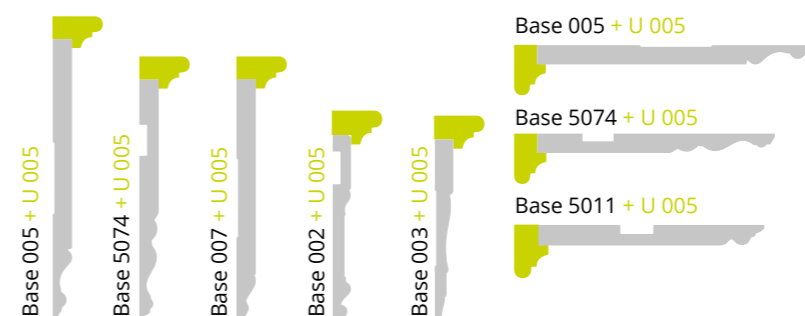
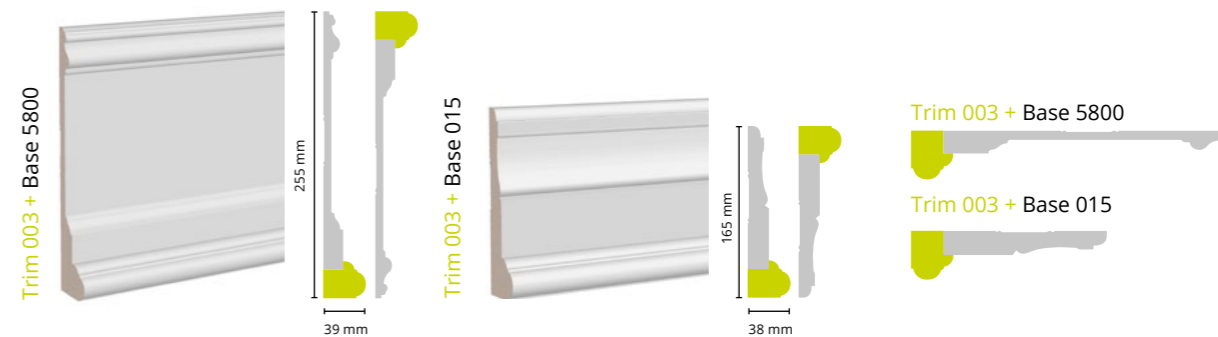

- La cimaise U 005 peut s'abouter avec les plinthes et les chambranles de 15 mm d'épaisseur**.
- La cimaise Trim 003 peut s'abouter avec les plinthes et les profils de 19-20 mm d'épaisseur.

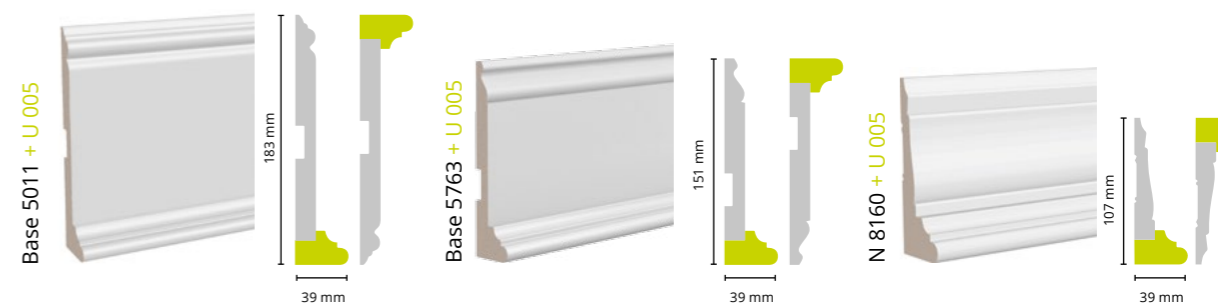

** Epaisseur 15 mm : Base 002, Base 003, Base 005, Base 007, Base 017, Base 020, Base 5011, Base 5074, Base 5270, Base 5271, Base 5272, Base 5340, Base 5763, N 004, N 8160.

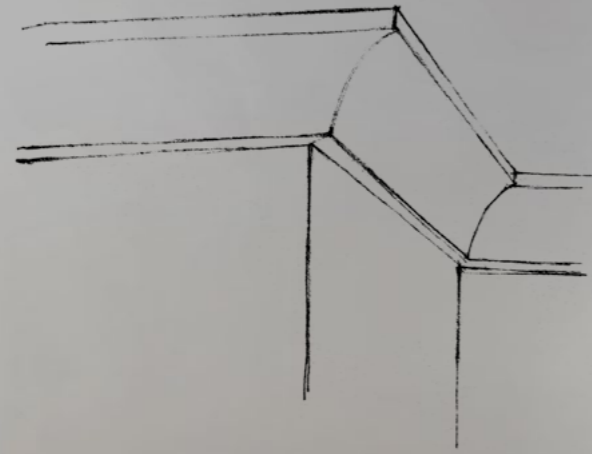

CORNICHES



La longueur de tous les profils est de 2440 mm

BEST-SELLER CR 001

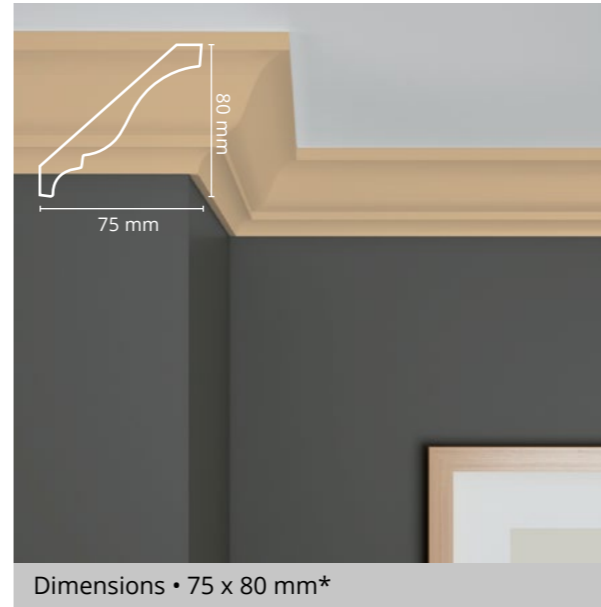

BEST-SELLER CR 002

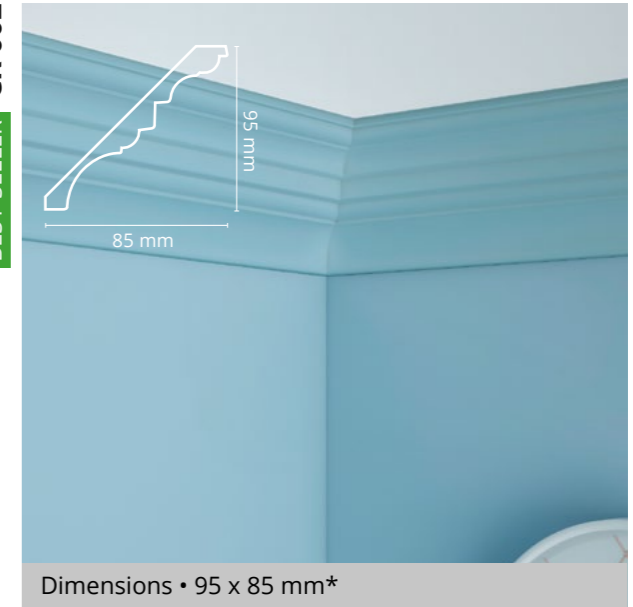

CR 003

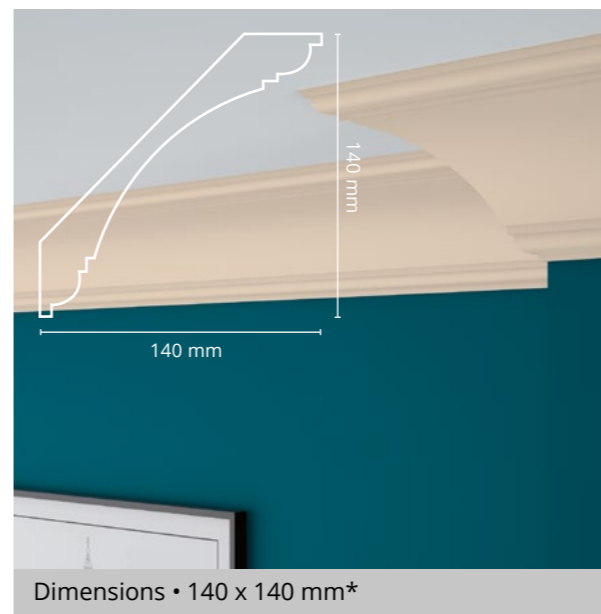

CR 012



* plus de détails sur les dimensions des corniches dans la section Dimensions, page 20-21

BEST-SELLER

CR 014

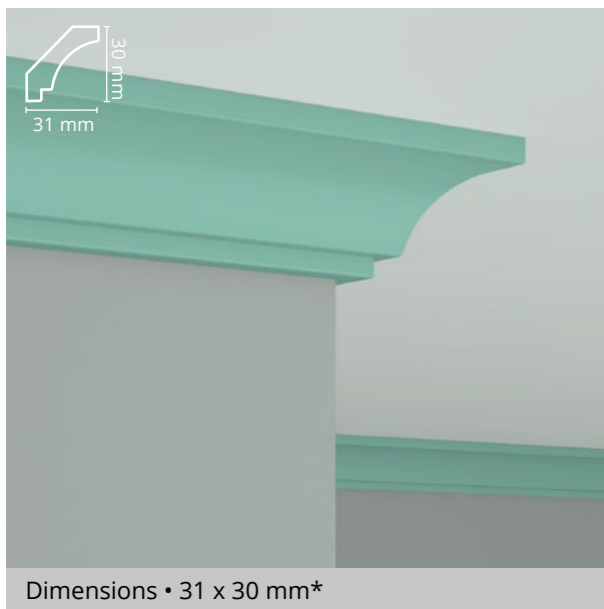

Dimensions • 31 x 30 mm*

CR 015



Dimensions • 48 x 48 mm*

CR 018



Dimensions • 76 x 76 mm*

CR 019

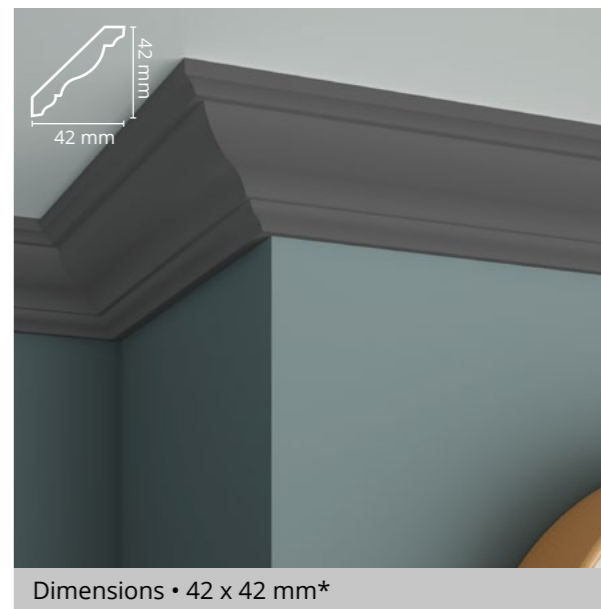

Dimensions • 42 x 42 mm*

CR 016



Dimensions • 67,5 x 67,5 mm*

CR 017

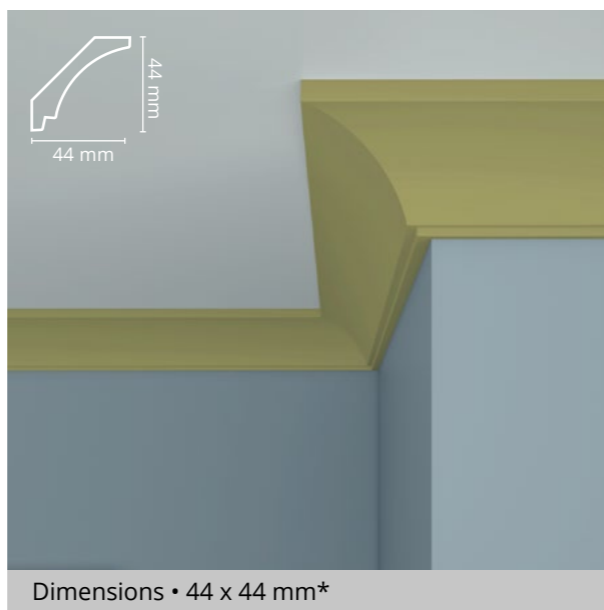

Dimensions • 44 x 44 mm*

CR 020

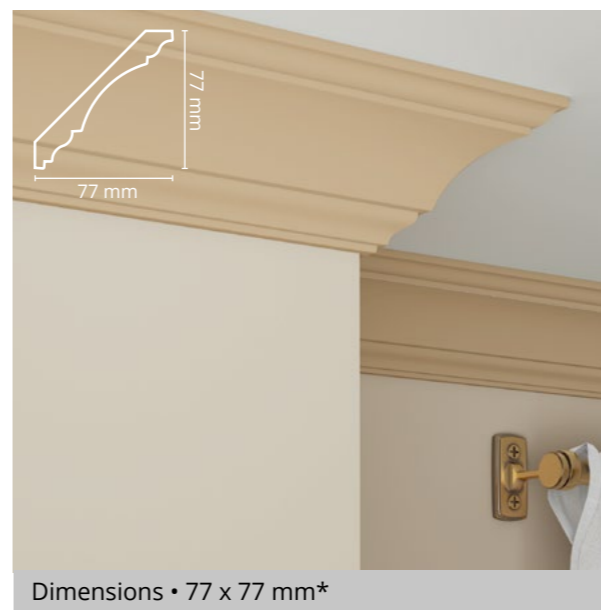

Dimensions • 77 x 77 mm*

CR 021



Dimensions • 46 x 46 mm*

* plus de détails sur les dimensions des corniches dans la section Dimensions, page 20-21

* plus de détails sur les dimensions des corniches dans la section Dimensions, page 20-21

NOUVEAU

CR 022

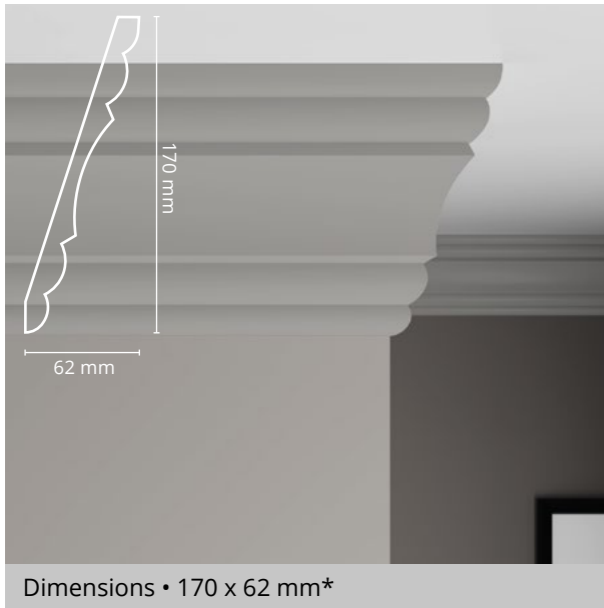

NOUVEAU

CR 023



NOUVEAU

CR 025

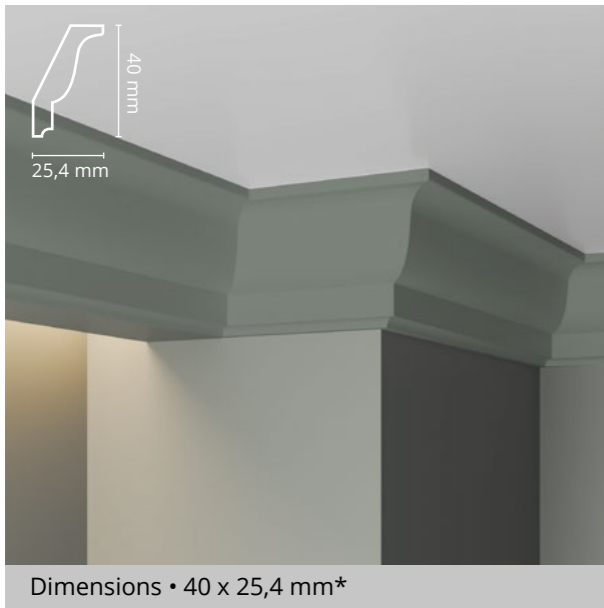

- Les corniches CR 022, CR 023 et CR 025 sont asymétriques et n'auront pas le même rendu en fonction de la pose verticale ou horizontale.

* plus de détails sur les dimensions des corniches dans la section Dimensions, page 20-21

BEST-SELLER

CR 2390

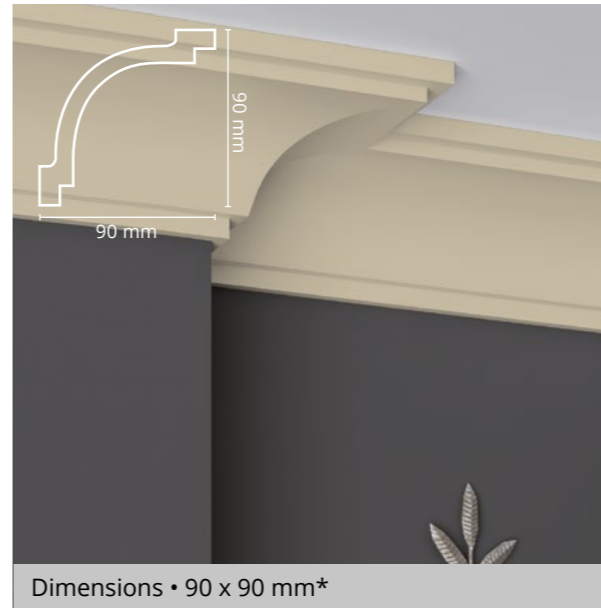

BEST-SELLER

CR 4080

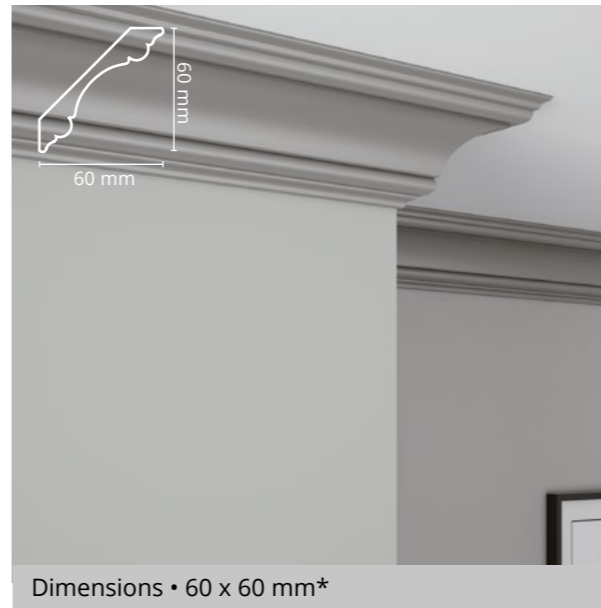

* plus de détails sur les dimensions des corniches dans la section Dimensions, page 20-21

CR 2335

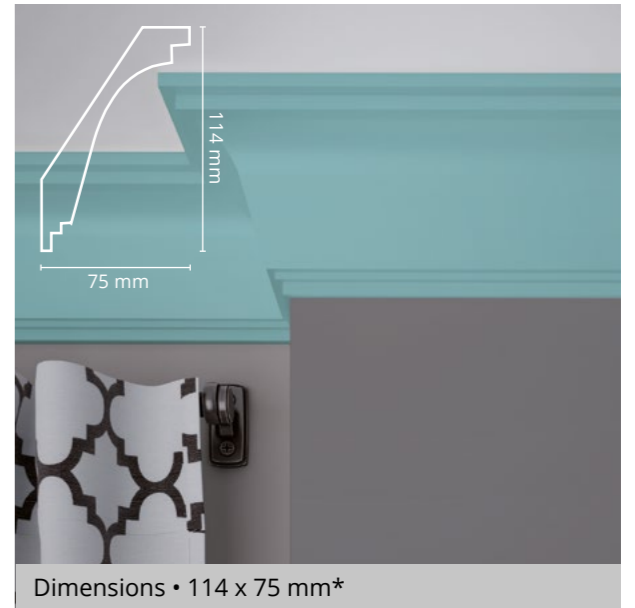

Toutes les corniches peuvent être retournées pour obtenir un effet visuel souhaité.

CR 4258



CR 4174

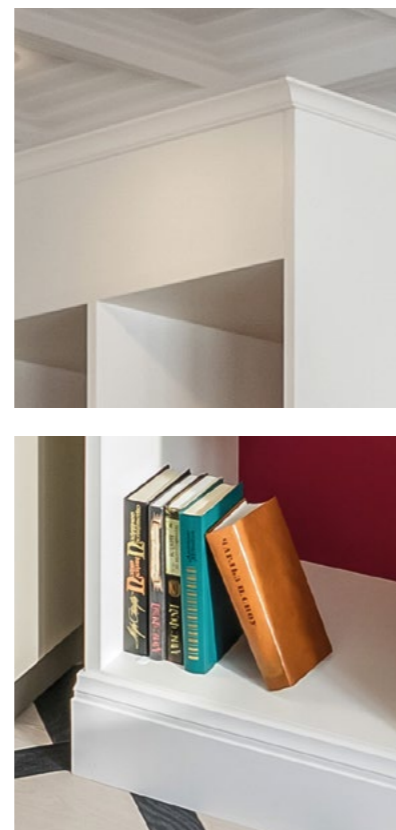
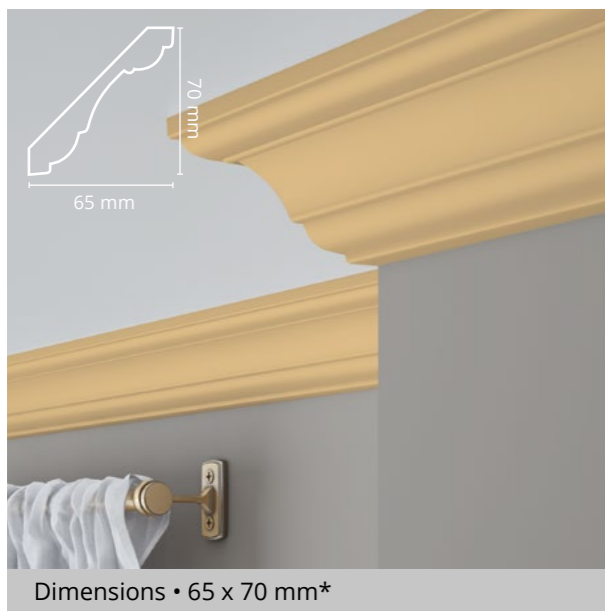

- Sur la photo 12 une étagère du style classique créé avec les corniches CR 014 et les plinthes Base 5214.



* plus de détails sur les dimensions des corniches dans la section Dimensions, page 20-21

ÉCLAIRAGE INDIRECT

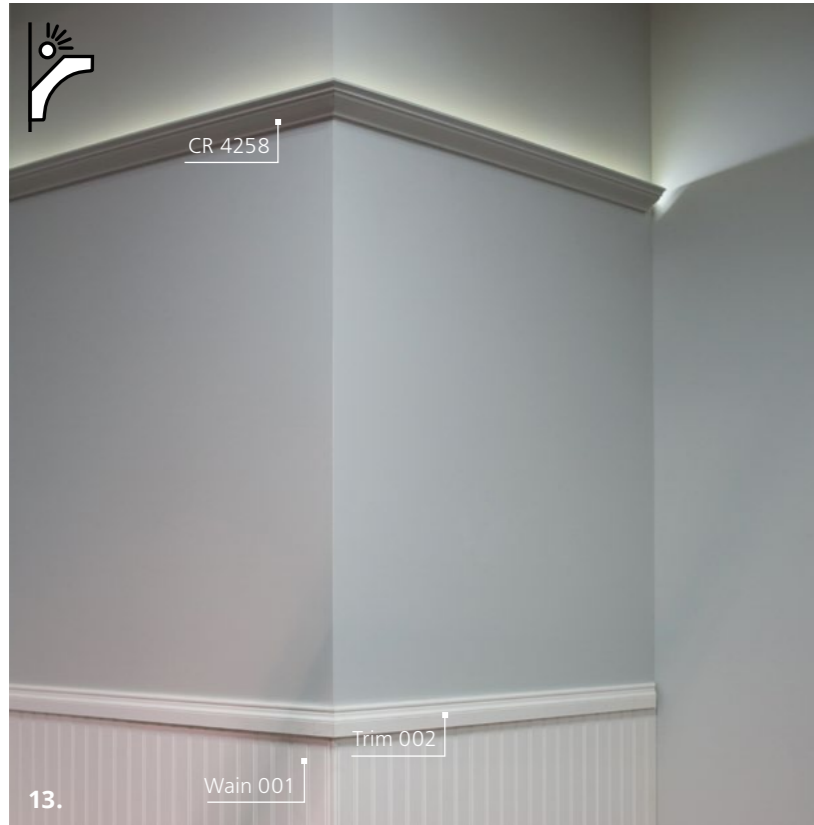

- Sur la photo 13 la corniche CR 4258 est utilisée pour l'installation de l'éclairage indirect.

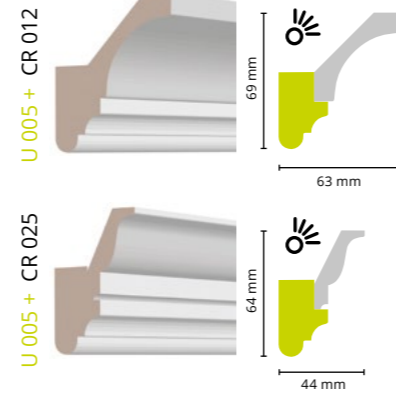

- Pour faire plus de place pour l'éclairage indirect on peut utiliser la cimaise U 005, comme expliqué sur les schémas ci-dessus.



- Sur la photo 14 les corniches CR 002 et CR 001 sont utilisées pour la décoration :
 - du plafond ;
 - des caissons ;
 - du portail.



IDÉES DES COMBINAISONS DES CORNICHES, CORNICHES COMPOSÉES

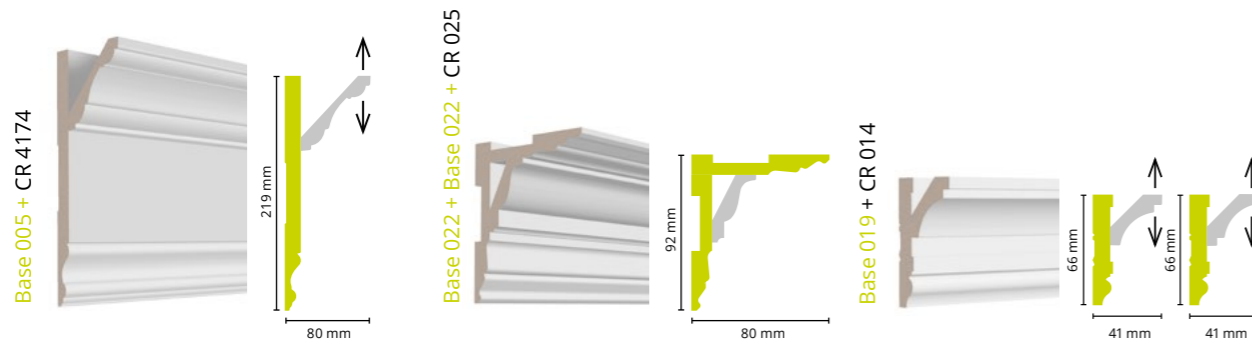
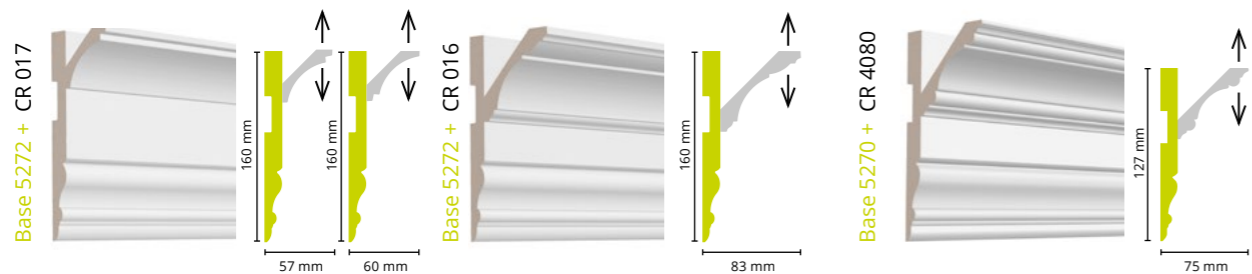

- Créez vos propres ensembles de profils Ultrawood pour une décoration d'intérieur unique.

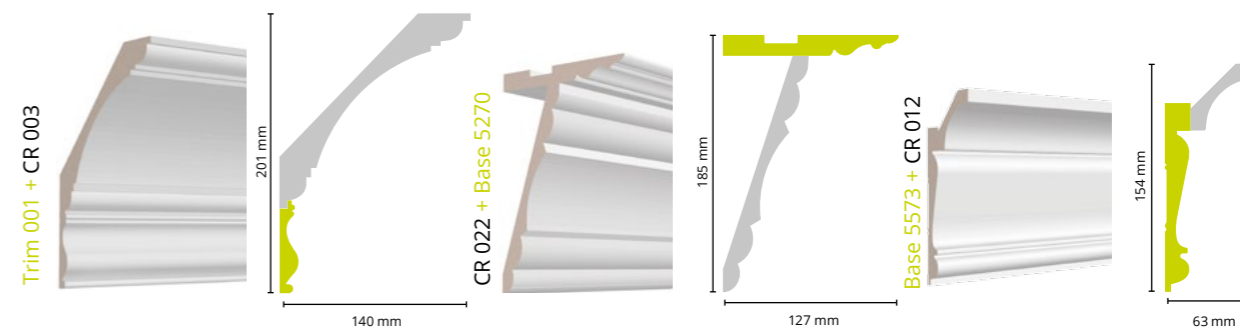
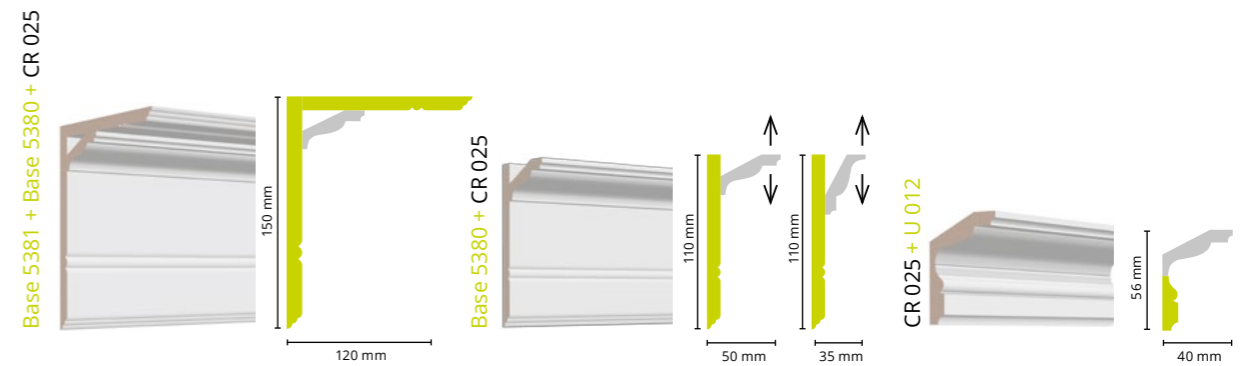
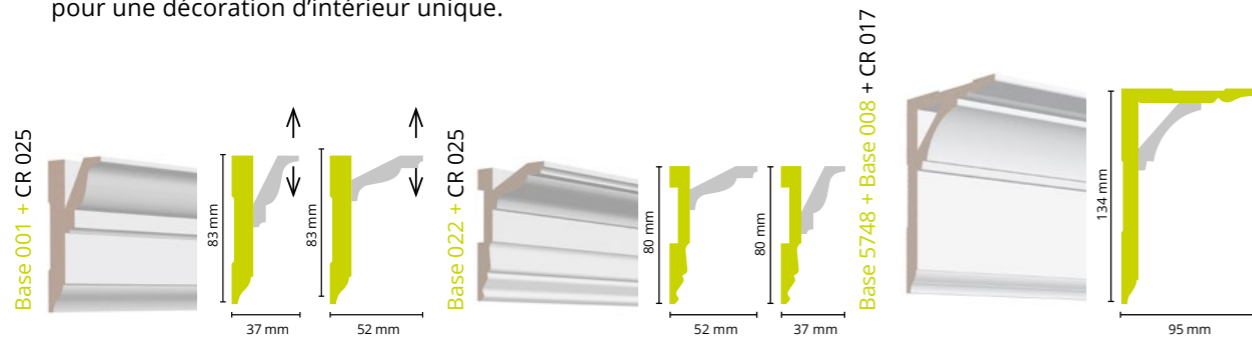

- Une corniche peut être composée de 2, voir plusieurs profils.

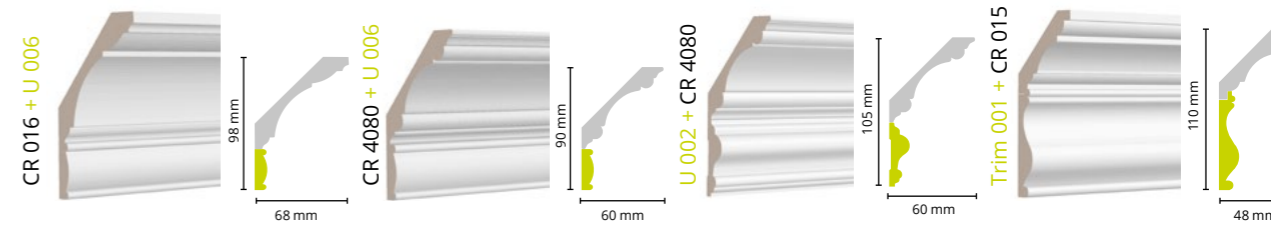

IDÉES DES COMBINAISONS DES CORNICHES, CORNICHES COMPOSÉES

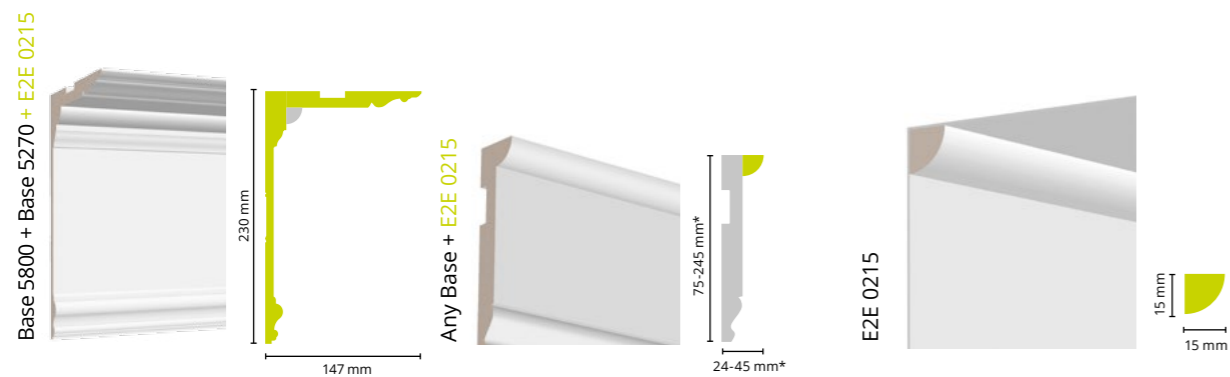
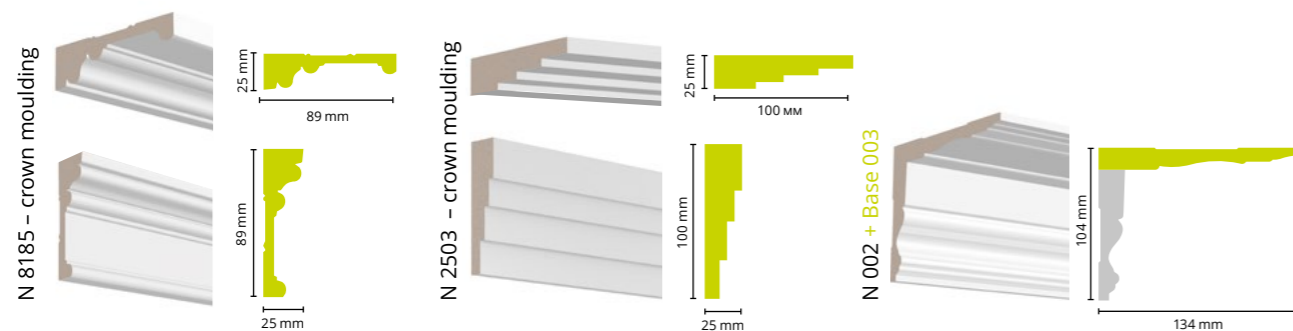

- Les plinthes, les cimaises ou les chambranles peuvent être posés en tant que corniches. C'est vous qui décidez.

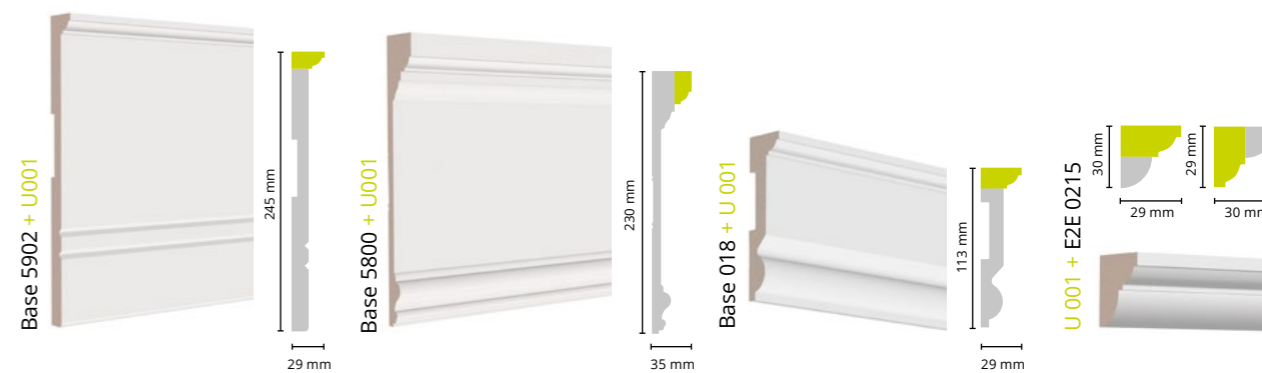
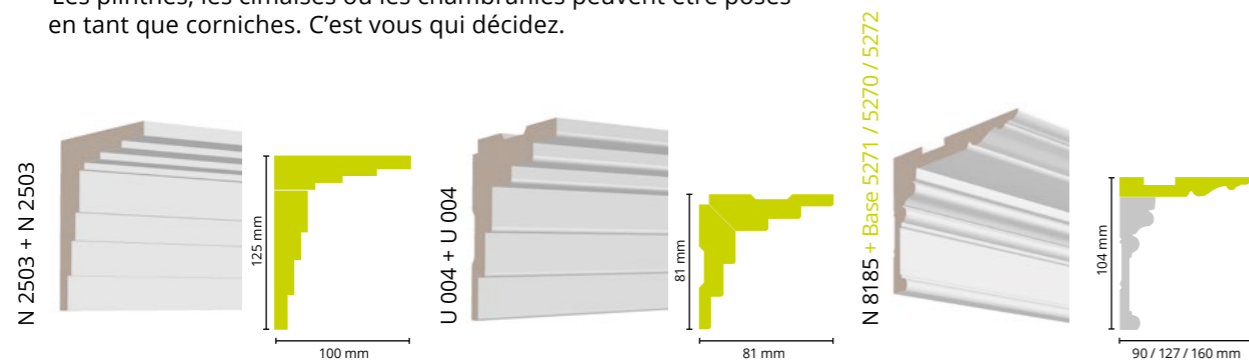

- La cimaise U 005 combinée à des plinthes ou des chambranles de 15mm d'épaisseur peut être utilisée comme une corniche*.

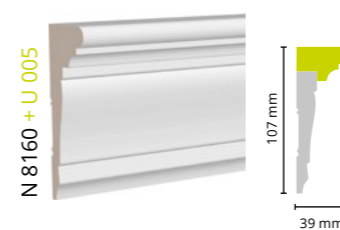

Base 005 + U 005

Base 5074 + U 005

Base 5800 + Trim 003

Trim 003 + Base 015

Base 005 + U 005

Base 5074 + U 005

Base 007 + U 005

Base 002 + U 005

Base 003 + U 005

- La cimaise Trim 003 peut être abouté avec les plinthes de 19-20 mm d'épaisseur.

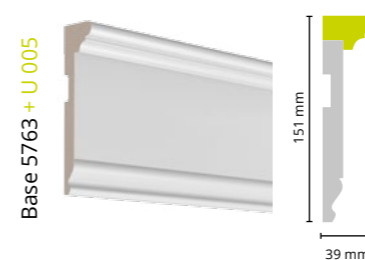

Base 5800 + Trim 003

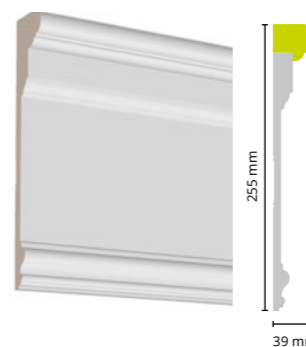

Trim 003 + Base 015

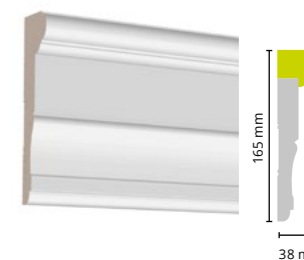

* Epaisseur 15 mm : Base 002, Base 003, Base 005, Base 007, Base 017, Base 020, Base 5011, Base 5074, Base 5270, Base 5271, Base 5272, Base 5340, Base 5763, N 004, N 8160.

IDÉES DES COMBINAISONS DES CORNICHES : CAISSONS

BO 0518 + BO 4112 + CR 016 + U 012 + E2E0215 + U 021

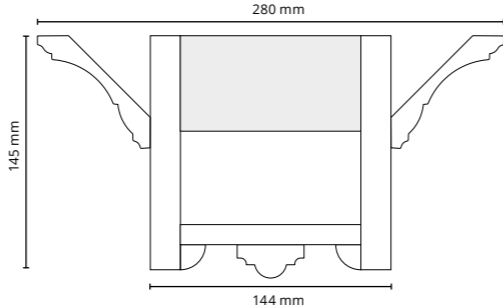
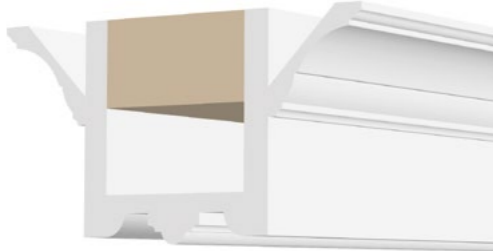

BO 0518 + CR 4258 + U 012

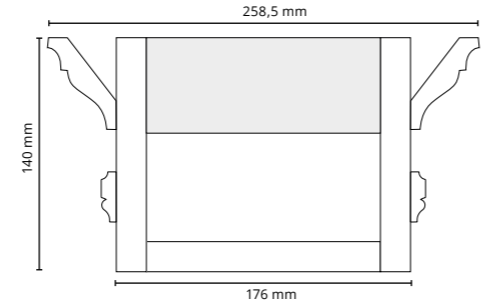
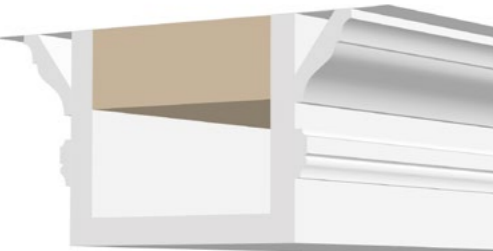

BO 4112 + CR 4258 (dessins A et B illustrent les options d'installation possibles)

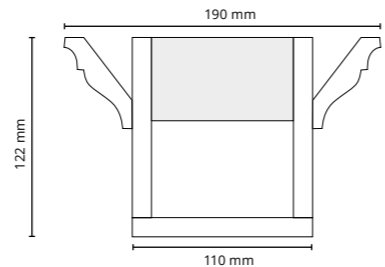
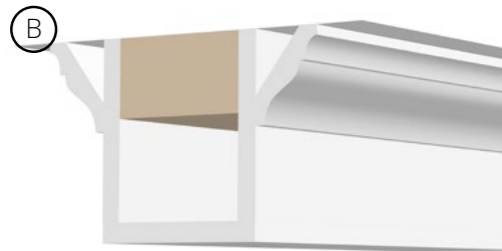
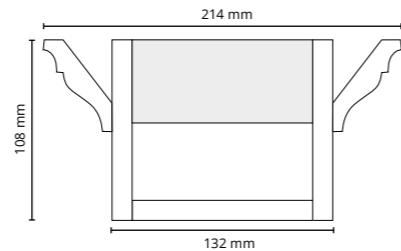
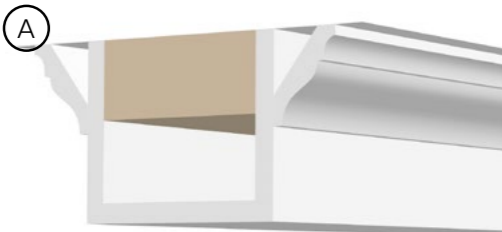

15.

CHAMBRANLES

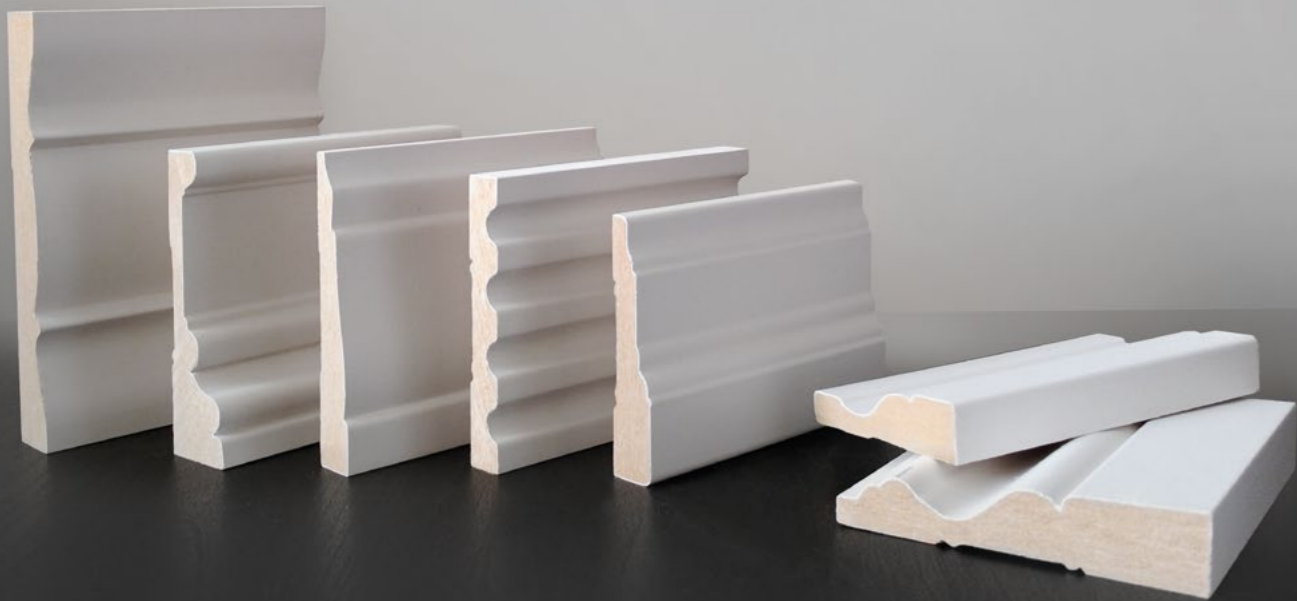

La longueur de tous les profils est de 2440 mm

N 002



Dimensions • 89 x 18 mm

BEST-SELLER
N 003



Dimensions • 83 x 12 mm

N 004



Dimensions • 71 x 15 mm

N 005



Dimensions • 130 x 19 mm

N 008



Dimensions • 80 x 10 mm

N 2503

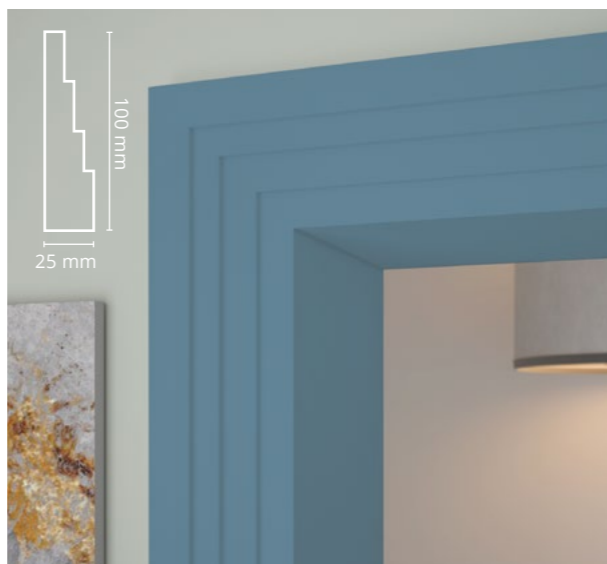

Dimensions • 100 x 25 mm

N 8414

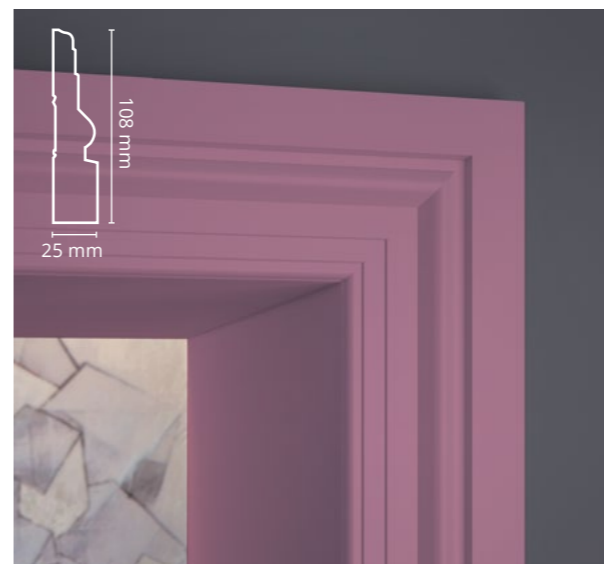

Dimensions • 108 x 25 mm

N 8500



Dimensions • 64 x 15 mm

N 8160



Dimensions • 89 x 15 mm

N 8185



Dimensions • 89 x 25 mm

N 8513



Dimensions • 90 x 15 mm

- Les chambranles peuvent être utilisés pour encadrement des fenêtres et des portes, mais aussi en tant que plinthes ou cimaises décoratives.



16. Un fragment de projet de Elisaveta Bydreevskaya



- Sur les photos 16 et 17 le chambranle N 8185 est utilisé comme corniche et comme encadrement.

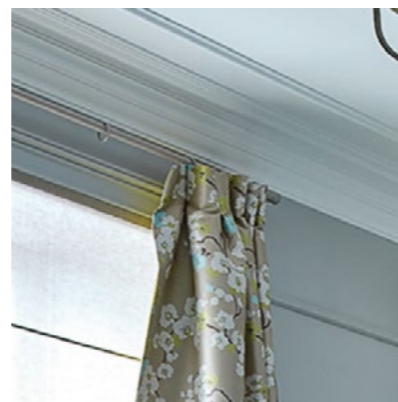

17. Un fragment de projet de Elisaveta Bydreevskaya

IDÉES DES COMBINAISON DES CHAMBRANLES

N 8185 + Base 5271/5270/5272

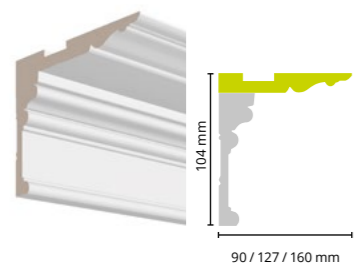

N 8185 – chambranles

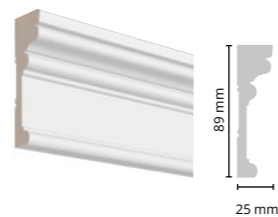

N 8185 – chambranles

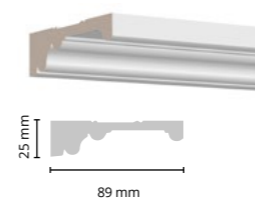

N 2503 + N 2503

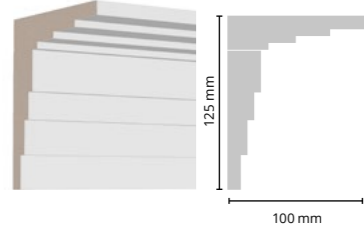

N 2503 – chambranles

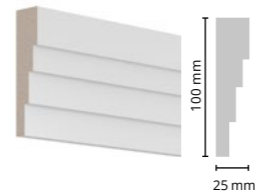

N 2503 – chambranles

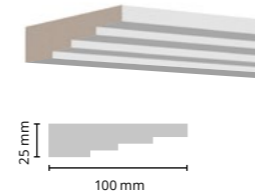

N 8185 + CR 025

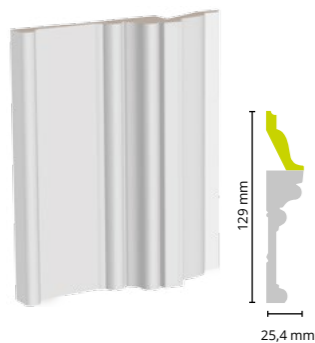

N 8414 + CR 025

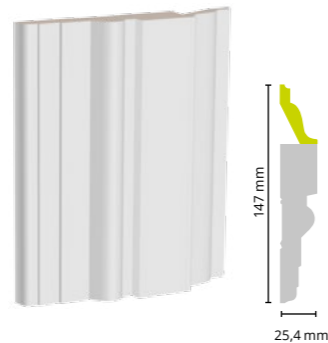

N 002 + Base 003

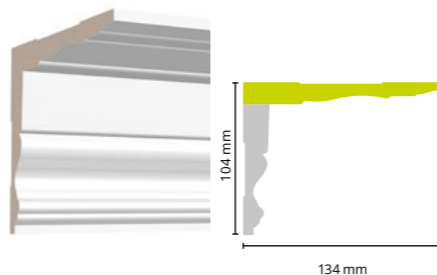

panneau avec des profils N 8160 (découpe à 45°)

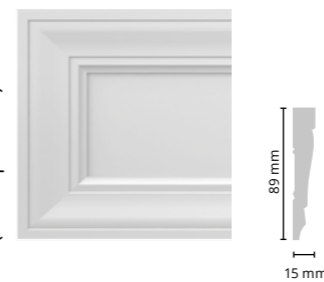

cadre avec des profils N 8414 (découpe à 45°)

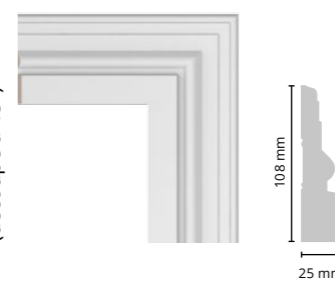

N 003 + D 1085



N 003 + D 2085

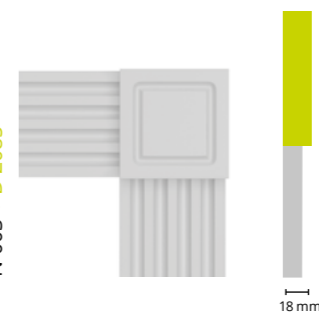

N 003 + D 3011



N 8160 + U 005

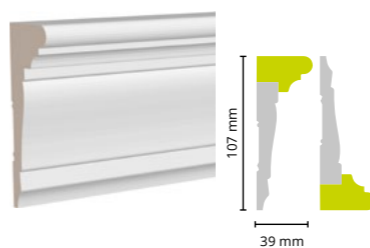

N 8160 + U 005

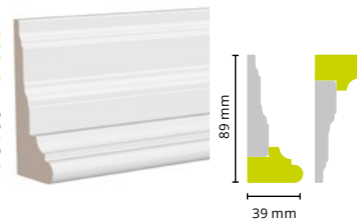

- Grâce à la découpe à 45° tous nos chambranles peuvent être utilisés pour créer :
 - un cadre,
 - un encadrement d'une porte,
 - un panneau mural.

- La cimaise U 005 combinée aux chambranles N 004 et N 8160 peut être utilisée comme une corniche ou comme une plinthe.



CIMAISES



La longueur de tous les profils est de 2440 mm

U 001



Dimensions • 29 x 15 mm

BEST-SELLER U 002

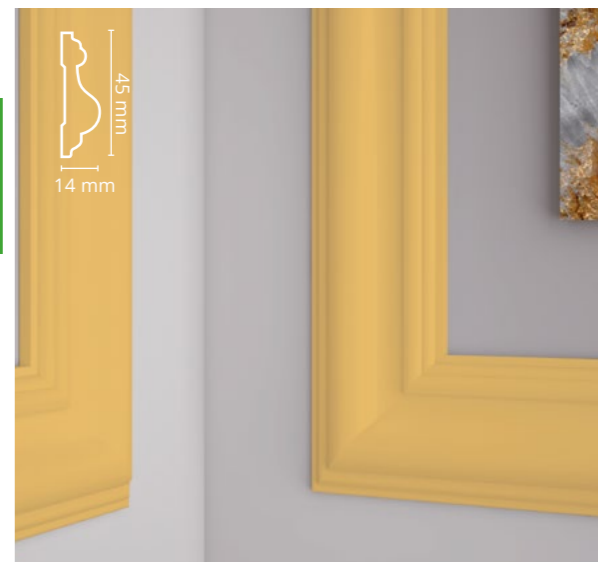

Dimensions • 45 x 14 mm

BEST-SELLER U 003

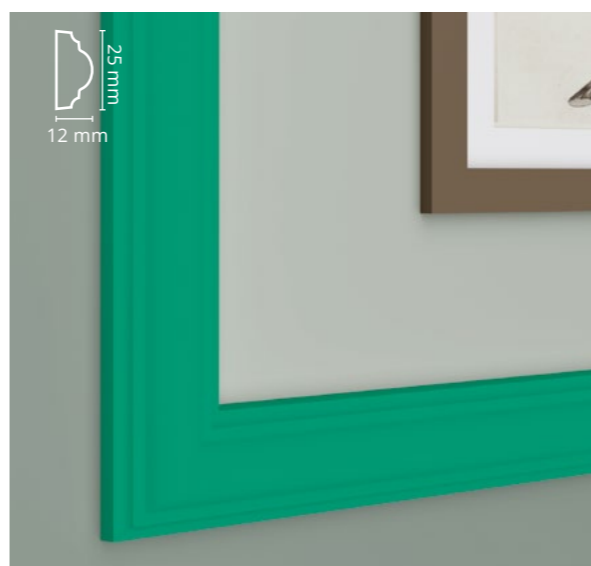

Dimensions • 25 x 12 mm

U 004

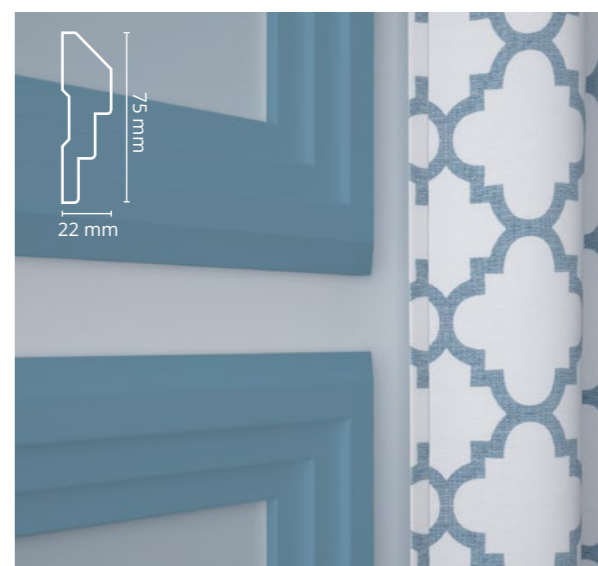

Dimensions • 75 x 22 mm

U 005



Dimensions • 39 x 25 mm

- La cimaise U 005 nous permet de faire une belle jonction entre un chambranle et une plinthe épaisse (jusqu'au 35 mm) - photo 18.

U 006

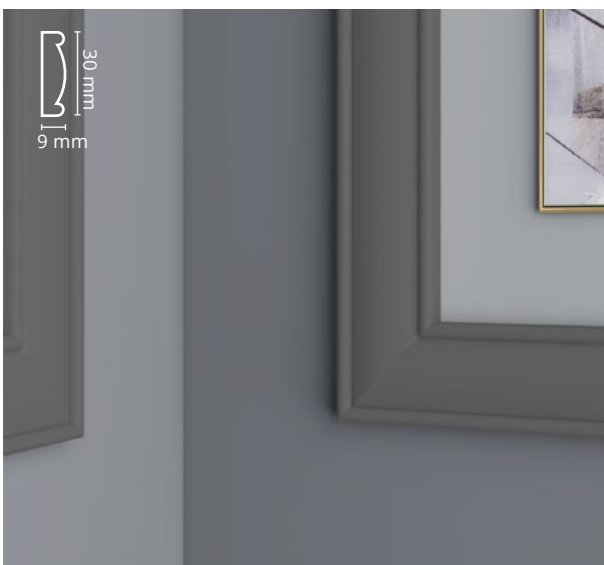

Dimensions • 30 x 9 mm

U 007



Dimensions • 38 x 14 mm

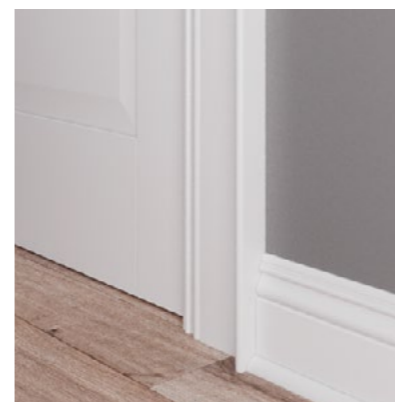

U 008



Dimensions • 44 x 12 mm

U 009

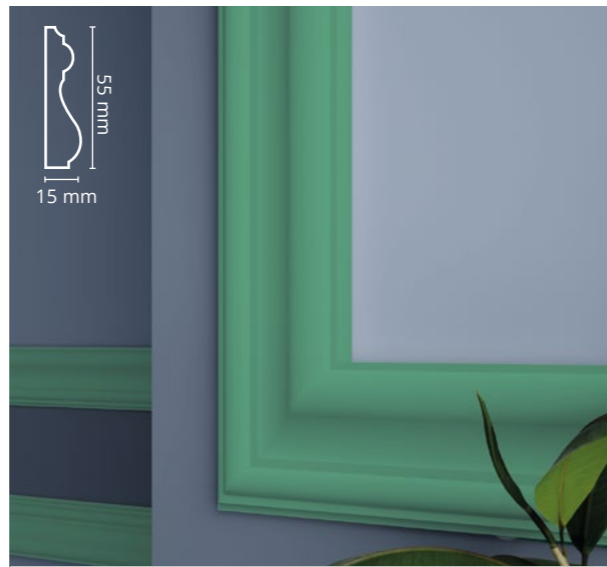

Dimensions • 55 x 15 mm

U 013



Dimensions • 70 x 15 mm

U 015



Dimensions • 85 x 18 mm

U 011



Dimensions • 31 x 9 mm

BEST-SELLER U 012



Dimensions • 30 x 9 mm

NOUVEAU U 020



Dimensions • 20 x 10 mm

U 021



Dimensions • 40 x 20 mm



19.

U 025

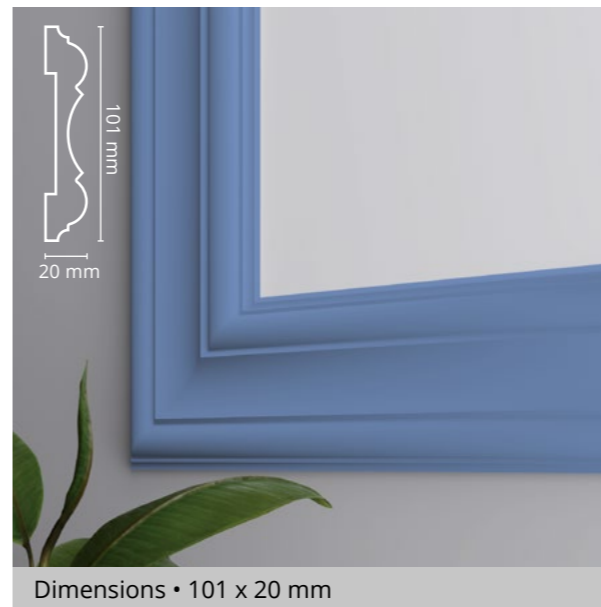

U 031



TRIM 001

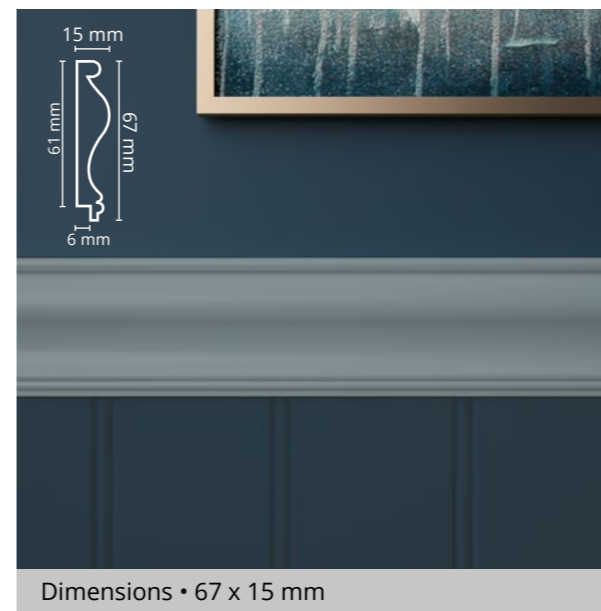

TRIM 002





20.

TRIM 003

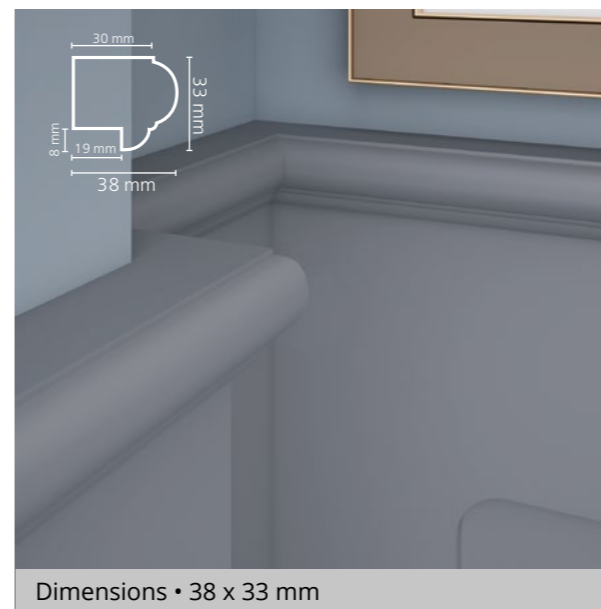

TRIM 003 A

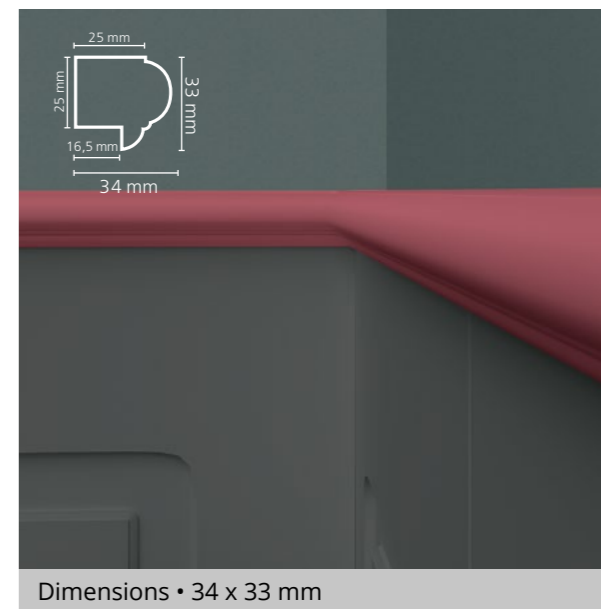

TRIM 004



- Sur la photo 20 les murs sont décorés avec des cadres faites avec des cimaises U 013



- Des caissons décoratifs faits avec des cimaises larges U 013.

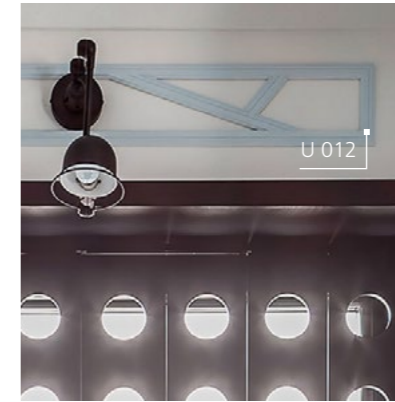

- Un panneau géométrique, pour accentuer la zone des fenêtres, fait avec les cimaises U 012.



IDÉES DES COMBINAISONS AVEC DES CIMAISES

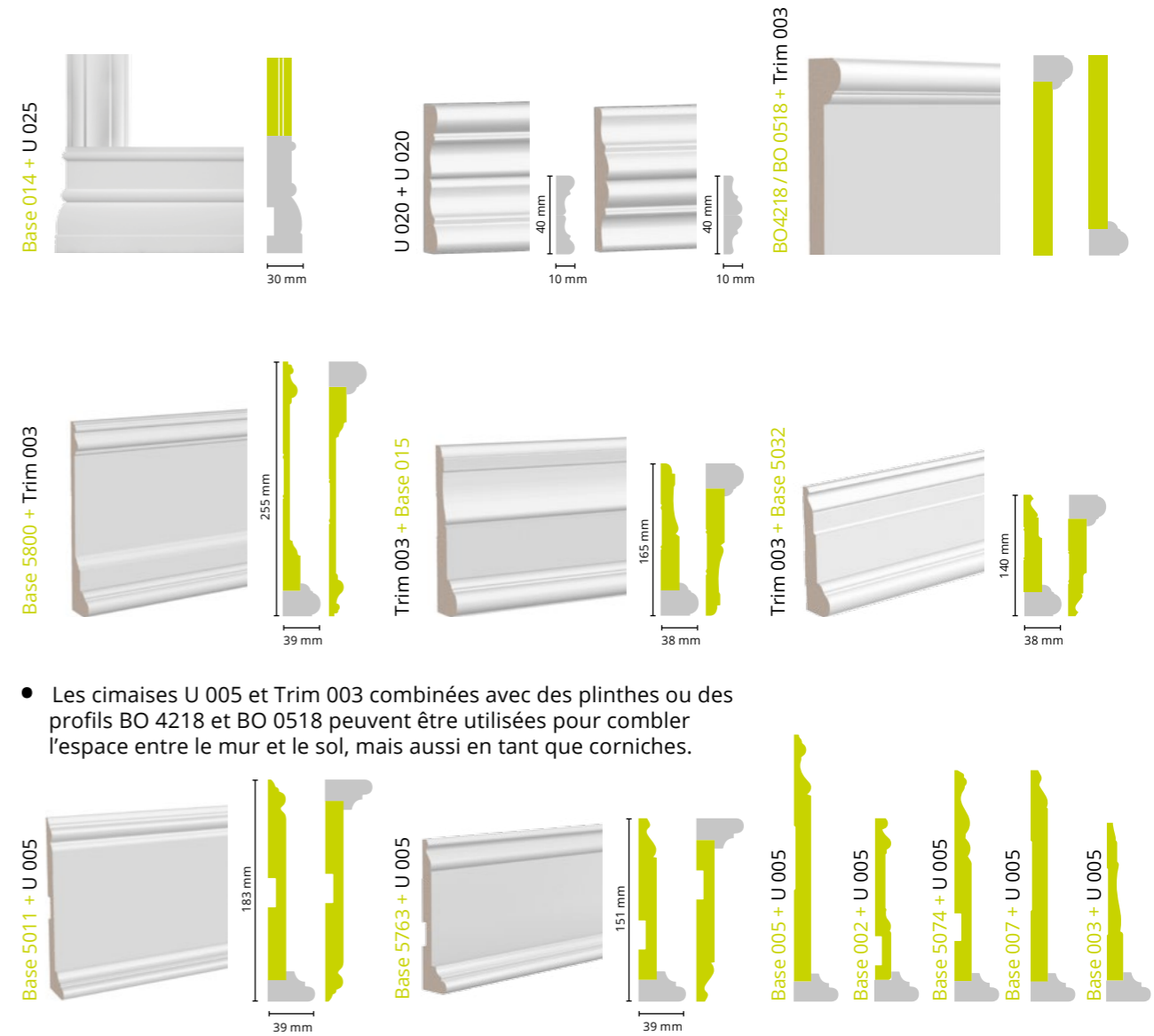
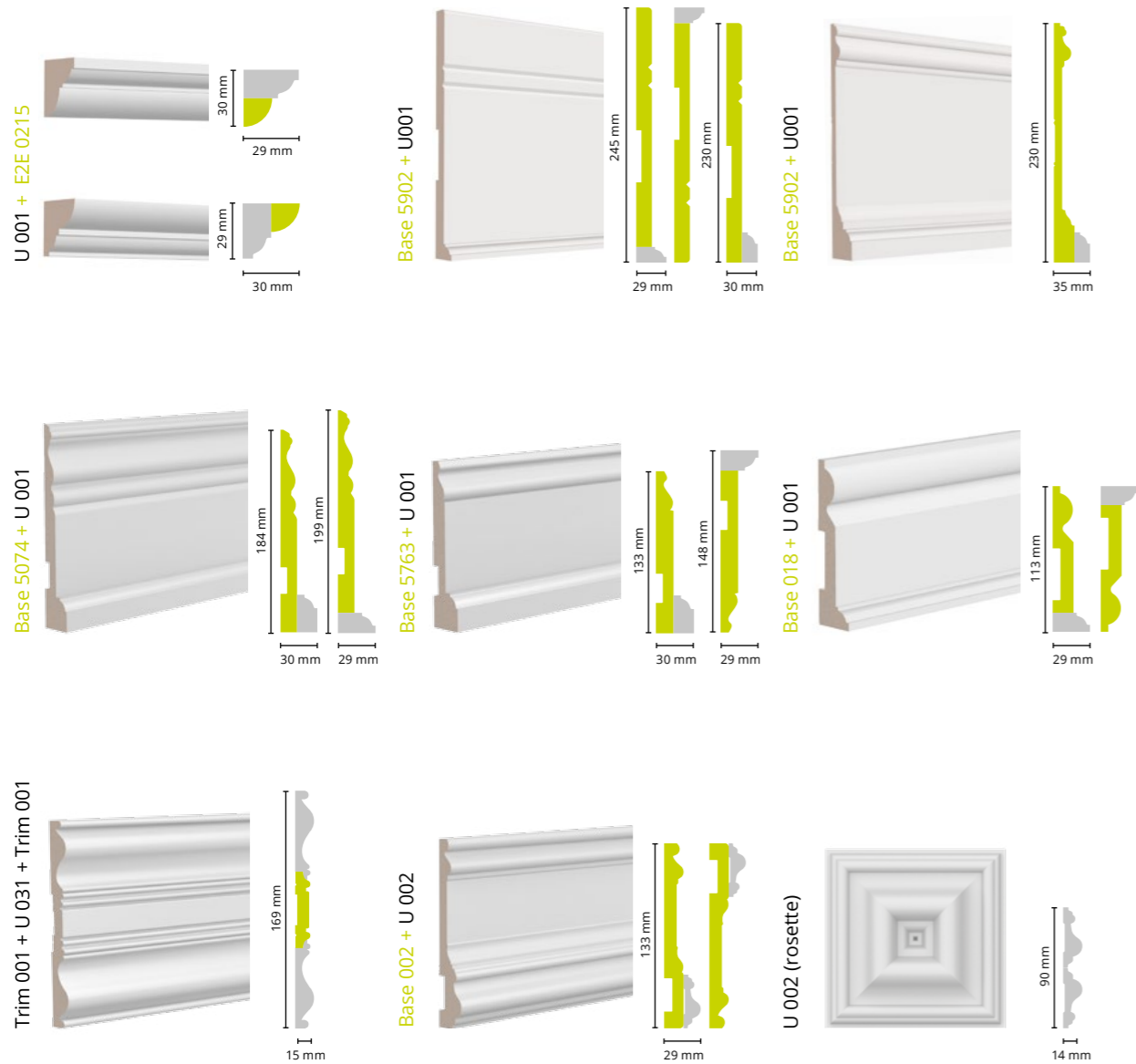

- Les cimaises U 005 et Trim 003 combinées avec des plinthes ou des profils BO 4218 et BO 0518 peuvent être utilisées pour combler l'espace entre le mur et le sol, mais aussi en tant que corniches.

IDÉES DES COMBINAISONS AVEC DES CIMAISES

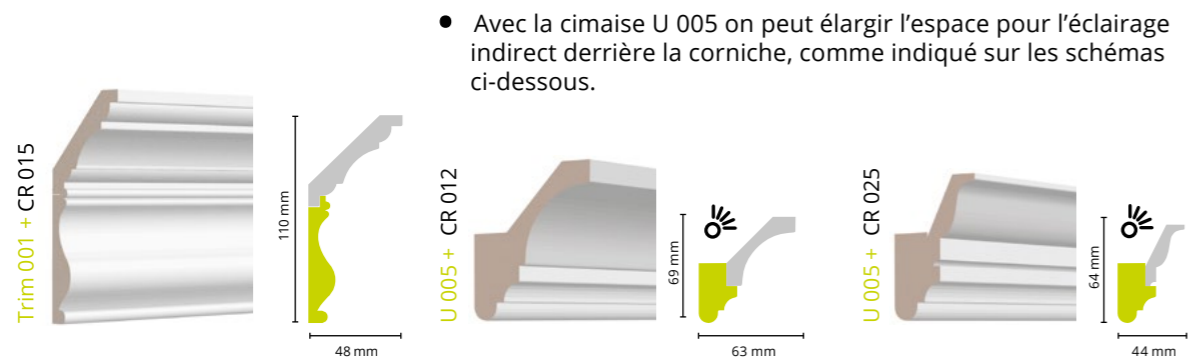
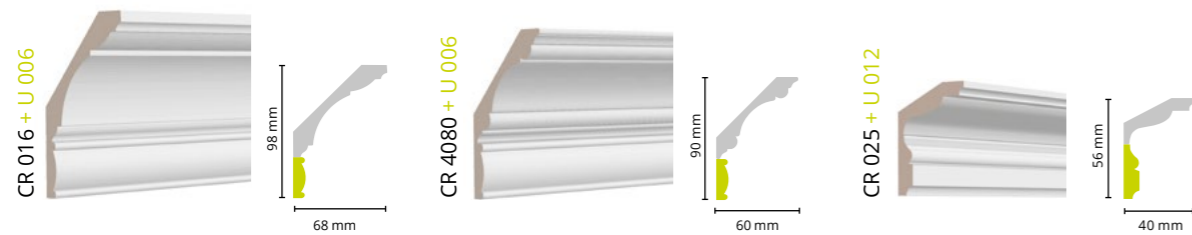
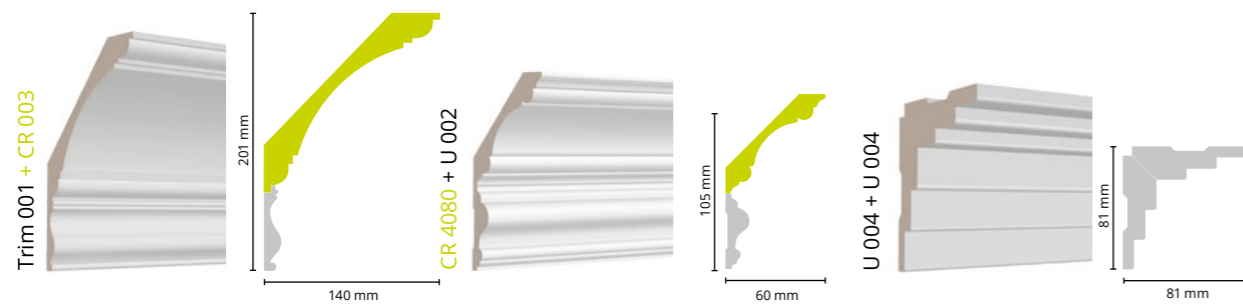

- Avec la cimaise U 005 on peut élargir l'espace pour l'éclairage indirect derrière la corniche, comme indiqué sur les schémas ci-dessous.

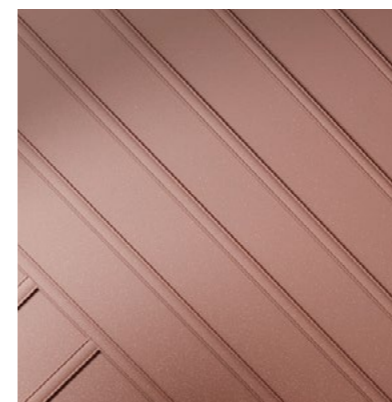

- Sur la photo 23 les murs sont décorés avec des cimaises U 006.

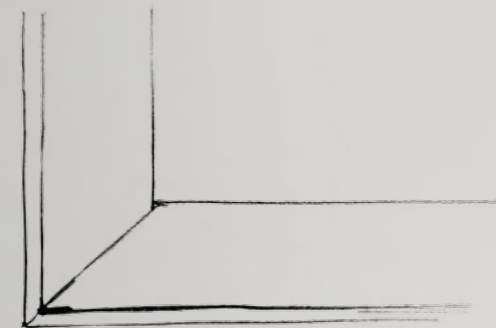

PROFILS



La longueur de tous les profils est de 2440 mm

NOUVEAU BO 1412



NOUVEAU BO 1712



BO 4218

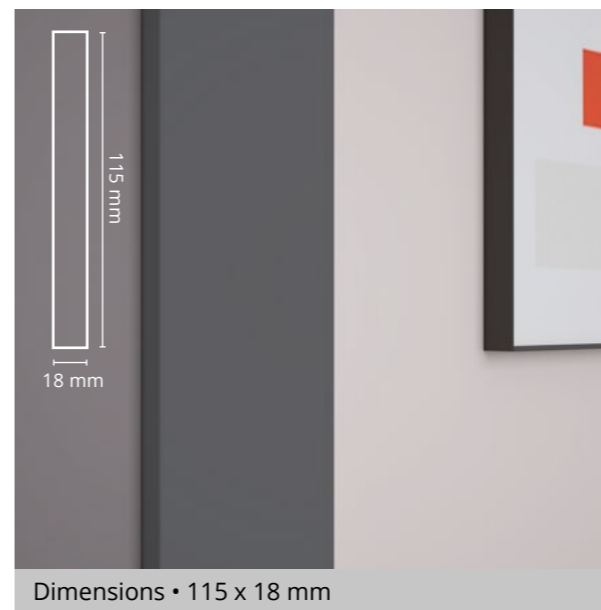

BO 0518



BEST-SELLER **E2E 0472**



BEST-SELLER **BO 4112**

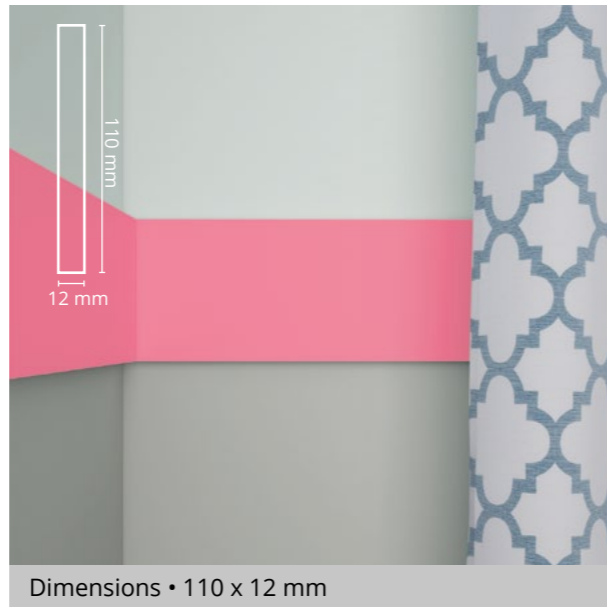

E2E 0215



E2E 9988



- Sur la photo 24 le mur est décoré avec le profil E2E 9988.

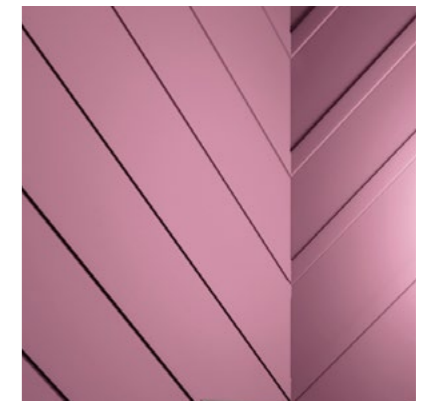
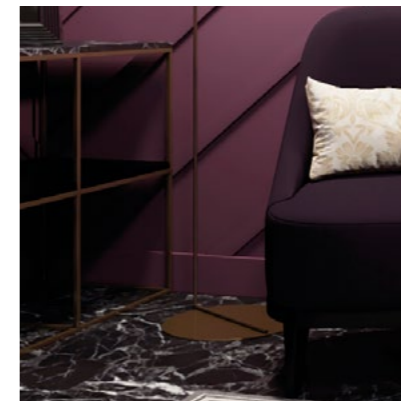

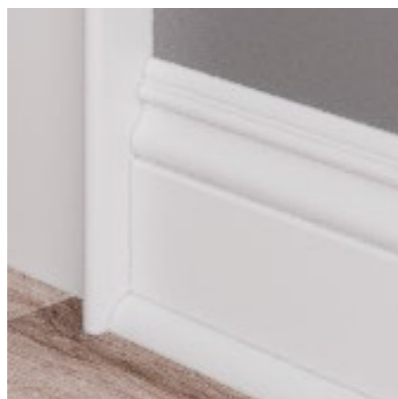

- Sur la photo 25 le profil E2E 9988 est utilisé sur le plafond.

Le profil E2E 0215 peut compléter une plinthe pour élargir sa base.



- Combinez les profils, créez des ornements, modulez l'espace avec les décorations en LDF.

Sur la photo 26 le profil E2E 9988.

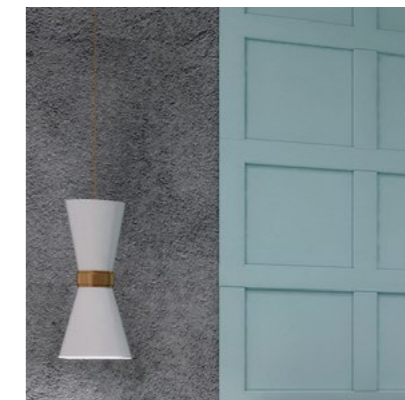
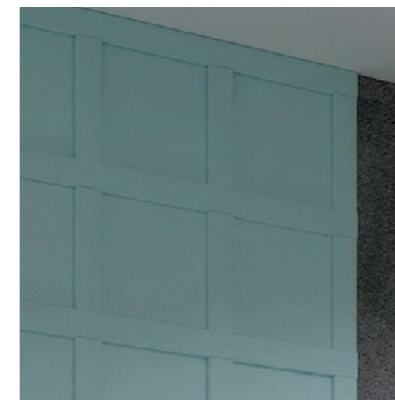

IDÉES DES COMBINAISONS AVEC DES PROFILS

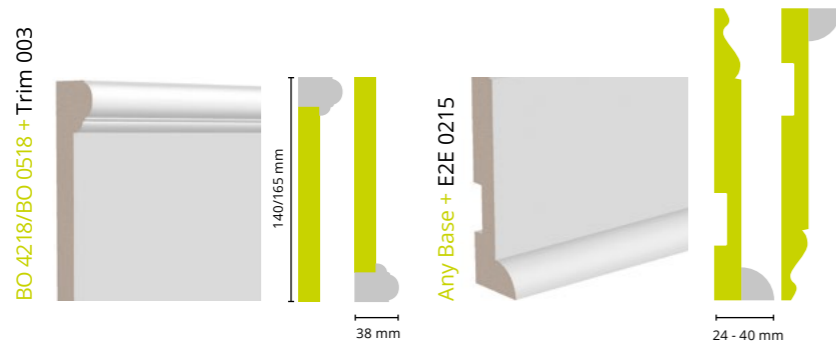

- EZE 0215 peut être combiné avec toutes nos plinthes pour combler l'espace entre le mur et le sol.



- EZE 0215 peut être utilisé comme :
 - une plinthe,
 - une corniche,
 - un angle externe ou interne.

Sur la photo 28 le profil EZE 0215 est utilisé pour la jonction de l'angle externe des panneaux UW 410 A.

28.

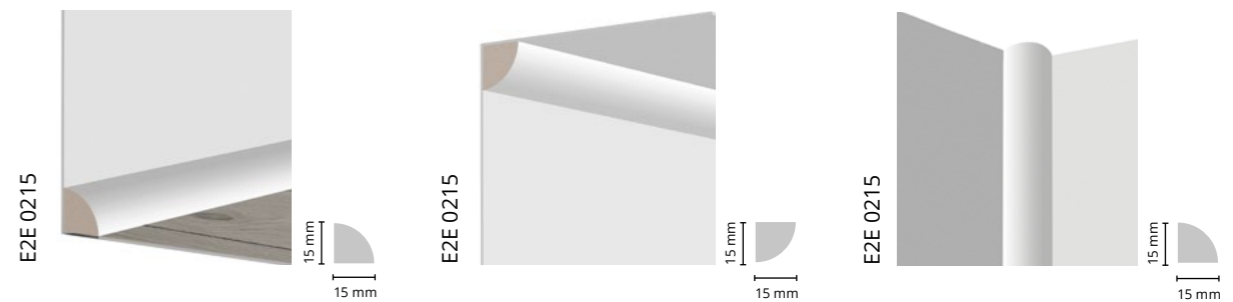

27.

PANNEAUX MURAUX

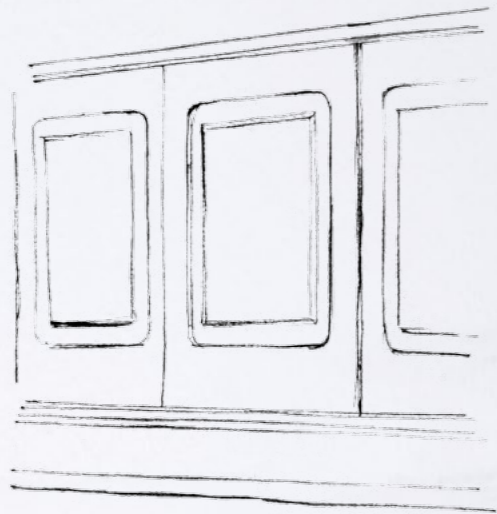

WAIN 001*

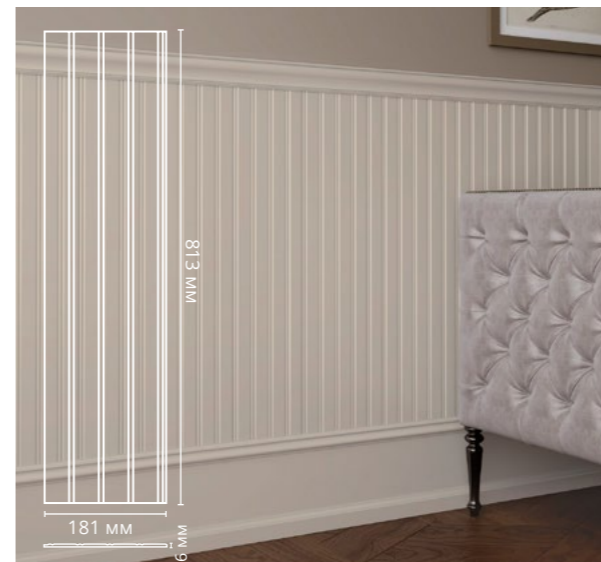

Hauteur • 813 mm, Dimensions • 181 x 6 mm

BEST-SELLER
WAIN 002*



Hauteur • 813 mm, Dimensions • 181 x 6 mm

WAIN 003*



Hauteur • 813 mm, Dimensions • 133 x 6 mm



- Il est recommandé d'installer les panneaux Wain 001, Wain 002 et Wain 003 en combinaison avec les cimaises de finition Trim 001, Trim 002 et Trim 004 et les plinthes Base.

* 6 pcs per packt

UW 410 A



UW 510 A



- Il est conseillé d'installer les panneaux UW 410 A et UW 510 A en combinaison avec les cimaises de finition Trim 003 A et les plinthes Base 012 et Base 014.

Pour faire l'adjonction des angles externes et internes des panneaux UW 410 A et UW 510 A il est conseillé d'utiliser le profil E2E 0215.





- Sur la photo 30 les panneaux muraux sont assemblés avec des profils Base 5271 et Base 5051

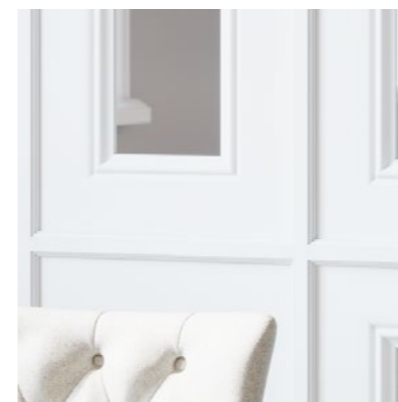
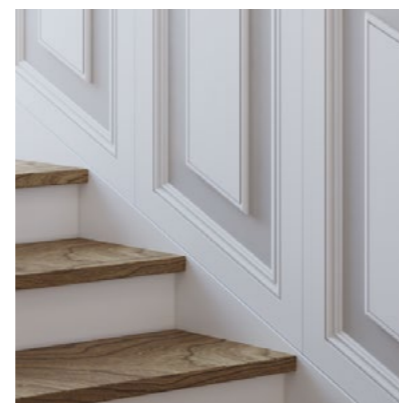

- Sur la photo 31 les cadres sont créés avec des profils de plinthes Base 5500 et cimaises U 007



ÉLÉMENTS DÉCORATIFS



D 1075

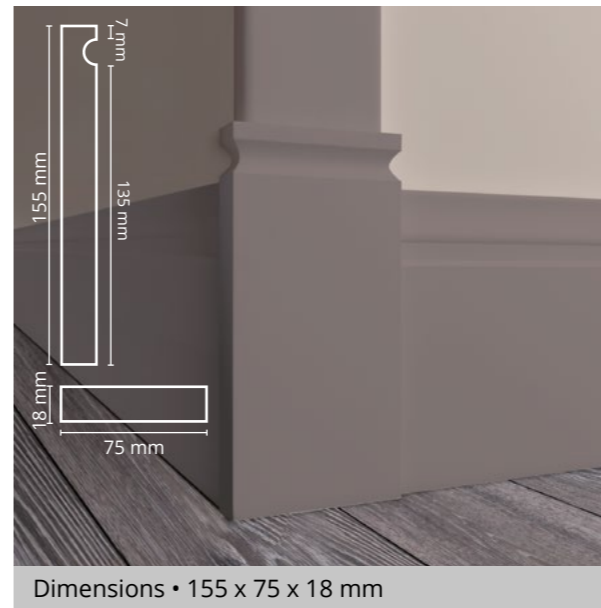

D 1085

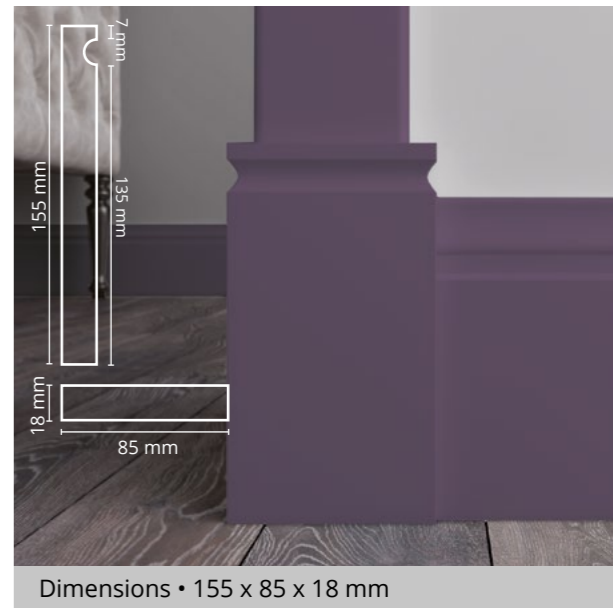

D 1095

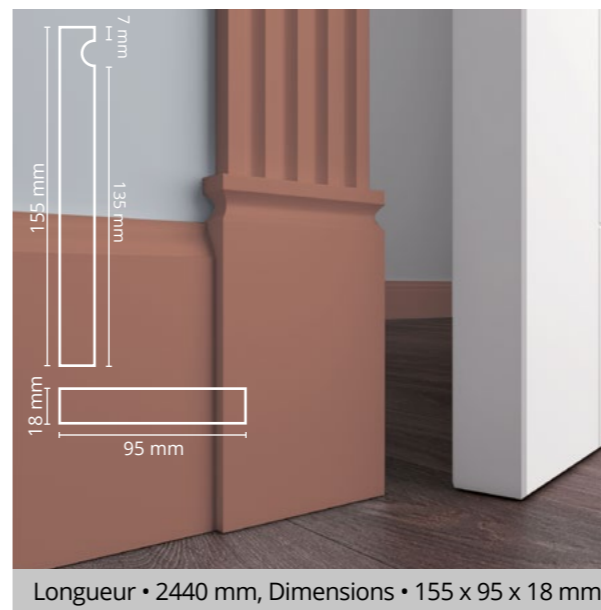

32.

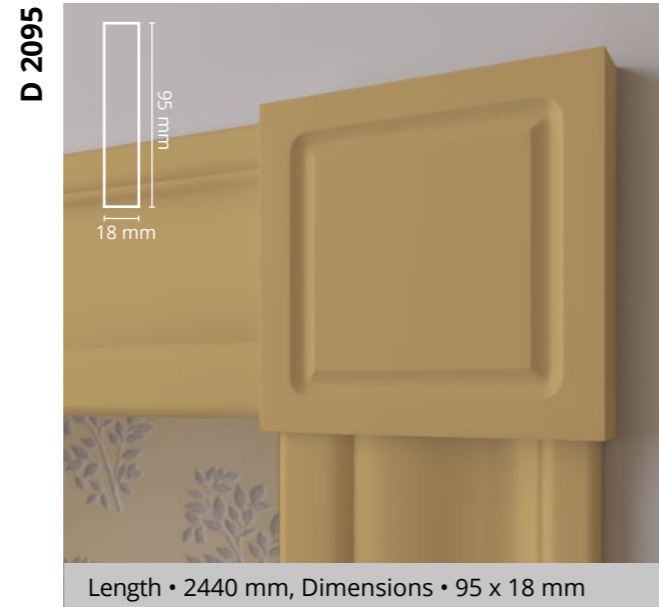
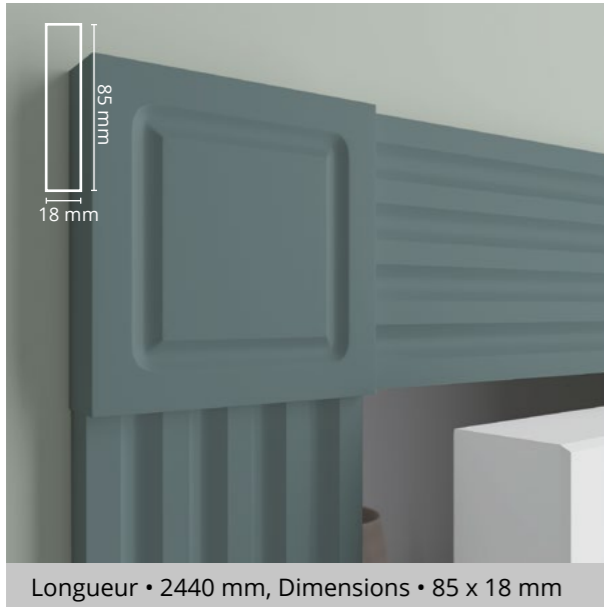

- Des profils avec un motif répétitif, mais avec des hauteurs différentes peuvent être utilisés comme plinthes et comme cadres de porte. L'essentiel est que les deux profils aient la même épaisseur. La photo 33 montre ainsi les profils Base 001 et Base 008.

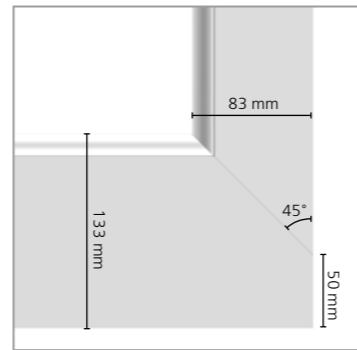

- L'image 34 illustre le design en demi-colonne pour décorer l'ouverture entre le couloir et la pièce.



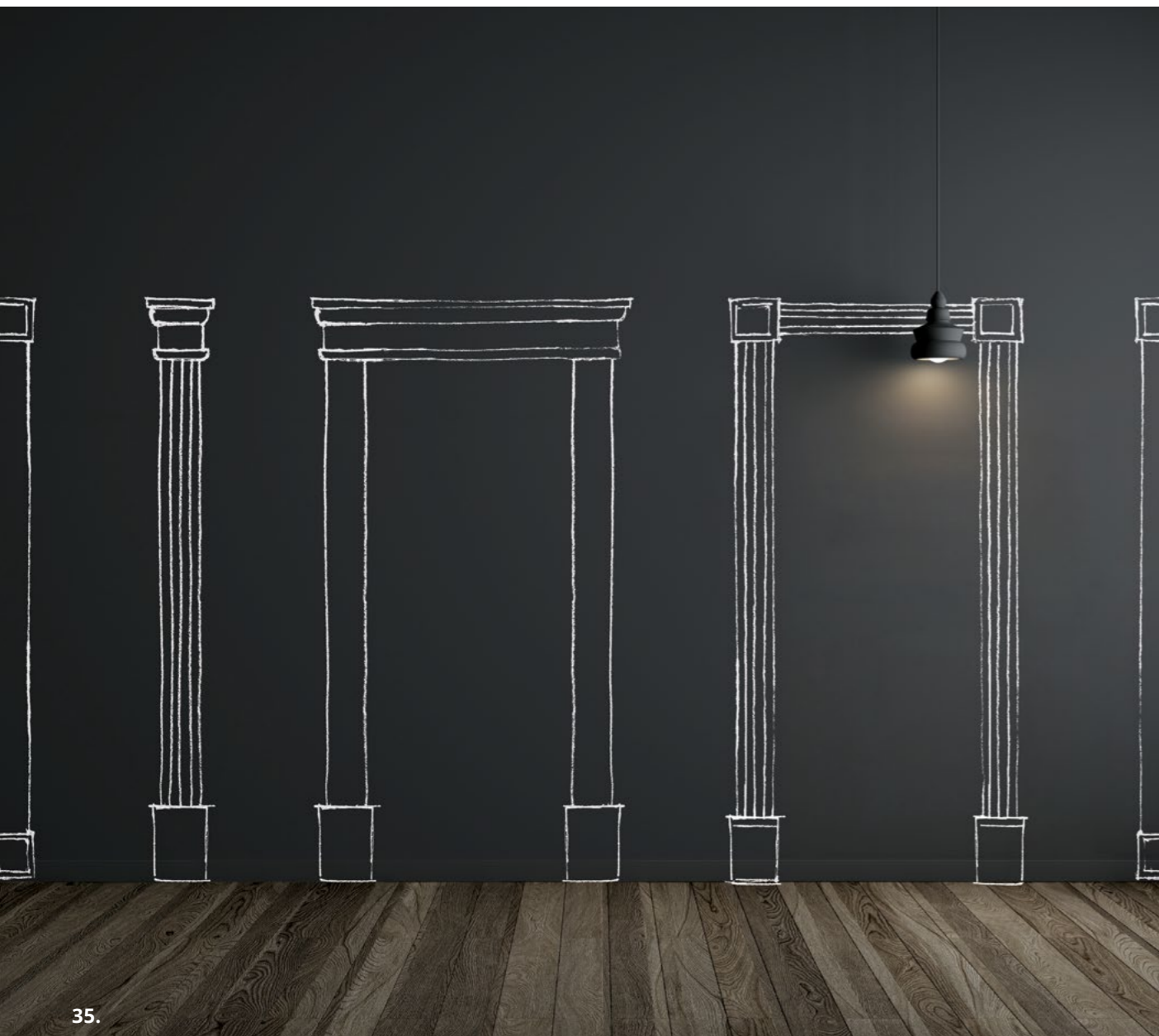

35.



- Les éléments décoratifs peuvent être utilisés :
 - pour décoration de portes ;
 - pour délimiter l'espace ;



- pour décorer une baie d'une porte ;



- comme chambranle.

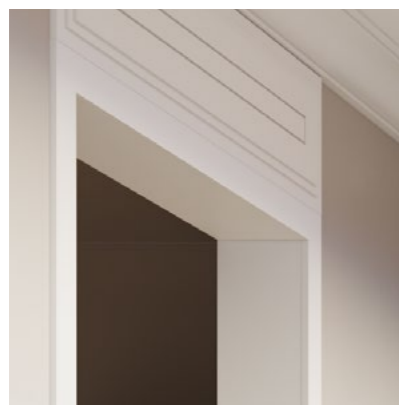

- Sur les photos 36 et 37 la plinthe Base 006 est utilisée :
 - pour encadrer une baie de la porte décorative ;
 - comme un dessus de porte ;
 - comme une plinthe.



Éléments appariés

- À l'aide d'éléments de décoration appariés, vous pouvez créer une déco de différentes pièces d'un appartement dans le même style.



Comment installer le décor LDF?

Le décoration d'intérieur en LDF ULTRAWOOD est destinée à la décoration de murs intérieurs dans des pièces avec l'humidité relative constante de 40% à 80%. La température pendant l'installation et les prochaines 24 heures ne doit pas être inférieure à + 8 ° C. Tout les profils ULTRAWOOD sont apprêtés et prêts à être peint.

• OUTILS D'INSTALLATION



Crayon, mètre ruban

scie radiale / scie sauteuse coupe fine, boîte à onglets*

Colle de montage et colle de raccord Ultrawood

Pistolet à clous / marteau + clous de finition (sans boule) / visseuse + vis auto-taraudeuses

Spatule

Papier de verre fin

• CALCULER LA QUANTITÉ DE PROFILS NÉCESSAIRE

1. Mesurez les surfaces en mètres linéaires
2. Nous recommandons d'ajouter une marge de 10% à la longueur résultante.
3. Additionnez des mètres linéaires de toutes les surfaces utilisant le même type de profils.
4. Divisez le nombre résultant par la longueur d'un profil.
5. Arrondissez la valeur résultante à un entier supérieur.

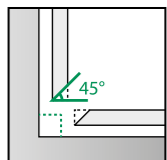

Coupe pour angle droit interne à 45°

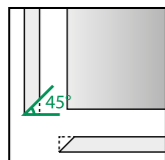

Coupe pour angle droit externe à 45°

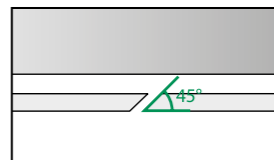

⚠ Assemblage sur une surface droite à 45°

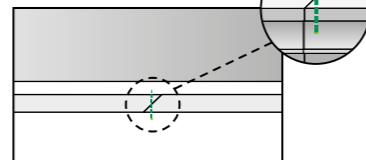

Il est conseillé d'utiliser une fixation supplémentaire sur les jointes.

* Si la hauteur du profil est supérieure à 14 cm, il est conseillé d'utiliser une scie radiale.



48 heures

Avant l'installation placez les profils dans la pièce pendant au moins 48 heures.

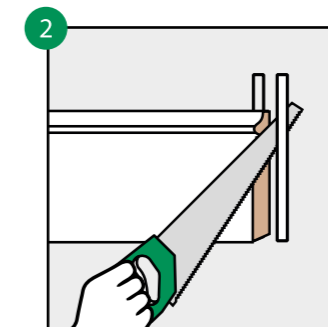

Coupez les profils à l'angle souhaité à l'aide d'une boîte à onglets et une scie sauteuse (ou scie radiale).

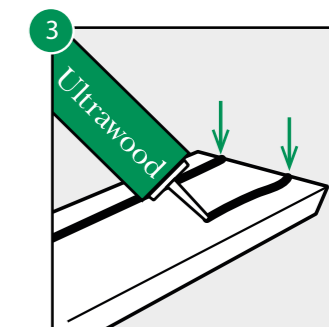

Appliquez la colle de montage Ultrawood à l'arrière de profil.

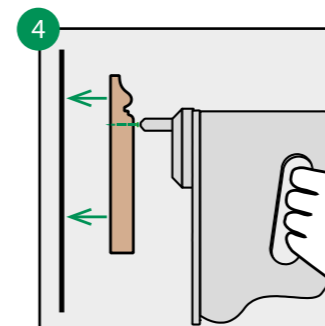

Collez le produit au mur. Pour une fixation plus forte il est conseillé de fixer les profils avec des clous en utilisant un pistolet pneumatique.

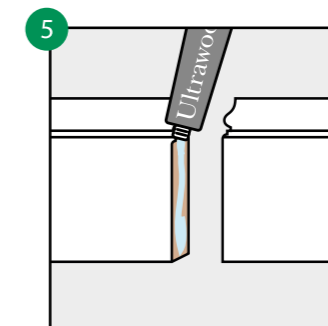

Apply excess Ultrawood bonding glue to the joint area. Glue profiles, lock until dry.

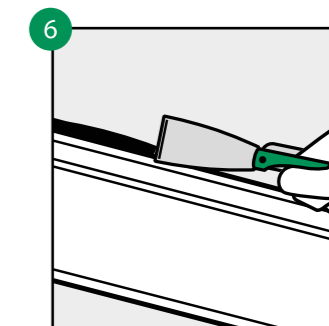

Retirez l'excédent de colle si besoin.



24 heures

Laissez sécher.

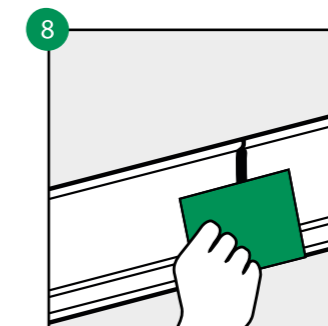

Lissez les joints des profils avec du mastic et du papier de verre à grain fin.

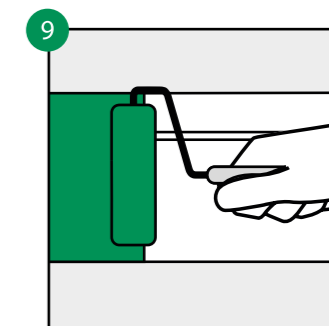

Maintenant, vous pouvez peindre*

* Nos produits sont compatibles avec tout type de peinture de finition. Pour les plinthes de plancher, nous recommandons l'utilisation des peintures lavables ou résistantes à l'humidité.

Idées de décoration colorées

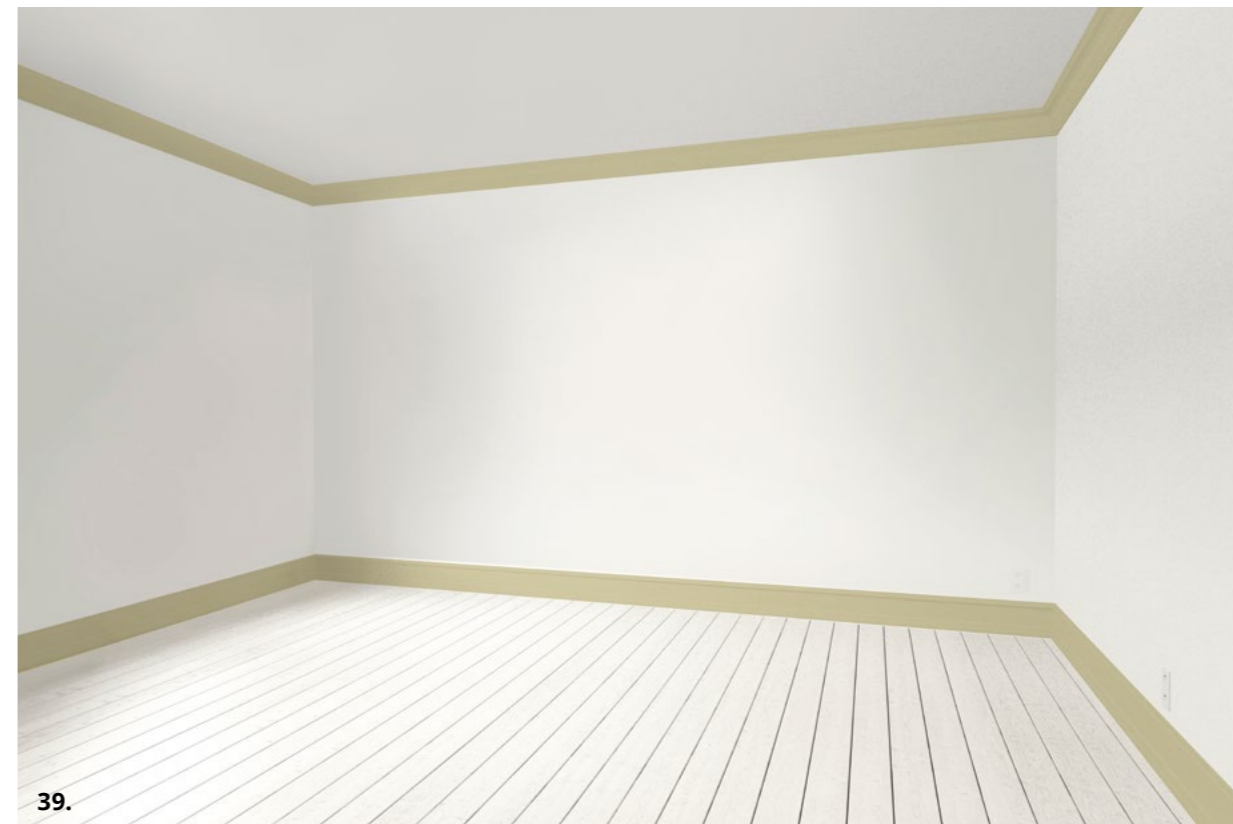
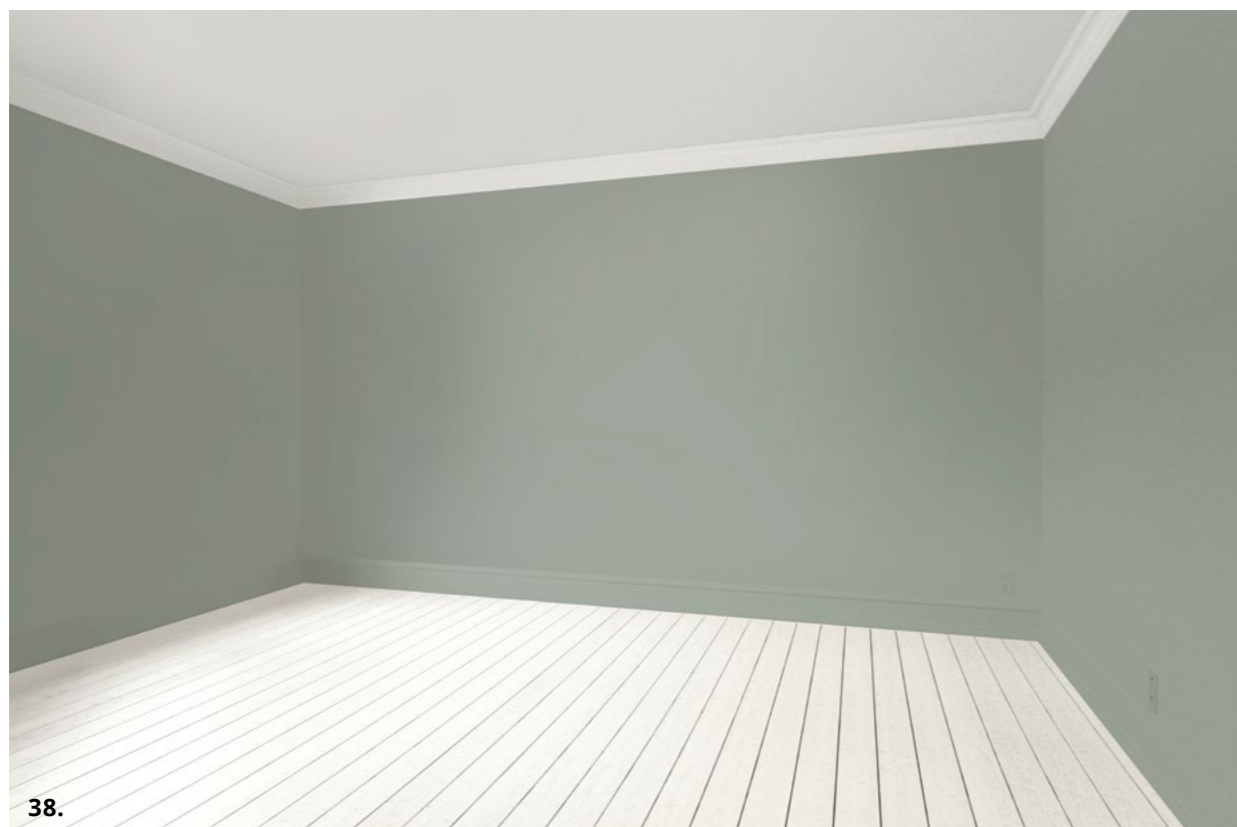

Gérez les proportions :

1. Une corniche de la même couleur que le plafond augmente visuellement le volume de la pièce (photo 38).
2. Une corniche de la même couleur que les murs augmente visuellement le volume de la pièce (photo 39).

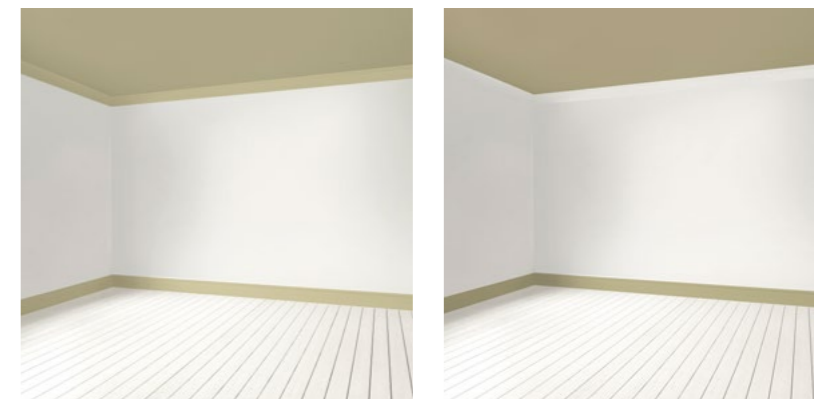



40.



41.



42.

Idées de décoration colorée

Peindre les murs est le moyen le plus simple de changer l'ambiance d'une pièce.

- **Abstraction.** La géométrie définit déjà le rythme, il est donc préférable d'utiliser des couleurs calmes et douces harmonieuses les unes avec les autres pour les pièces à vivre.
- **Monochrome.** Le décor et les murs sont peints d'un seul ton et constitueront une magnifique toile de fond pour des touches de couleur.
- **Contraste.** Option classique avec un décor blanc sur un fond coloré ou des combinaisons de couleurs modernes.

Partenariat



- Colonne (rotative) avec des échantillons des profils :
Hauteur : 2050 mm
Largeur : 500 mm
Base / toit : 780 x 780 mm
- Ensemble de 5 stands avec des échantillons des profils.
Dimensions d'un stand :
Hauteur : 1100 mm
Largeur : 500 mm
Épaisseur : 8 mm



- Boîte avec des échantillons des profils.
- Boîte avec des échantillons des assemblages des profils.

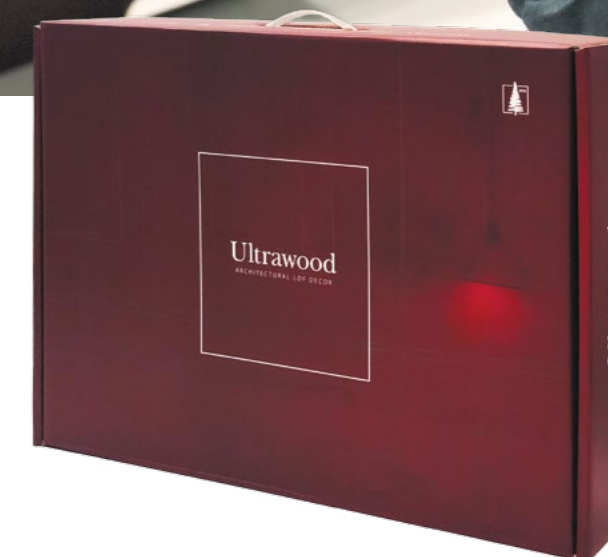

Colle de marque Ultrawood



COLLE DE MONTAGE, 310 ml

Consommation
approximative 10-12 m.l. :
- excellente adhérence
- séchage rapide
- couleur transparente



COLLE DE RACCORD, 80 ml

Consommation
approximative 35 m.p. :
- raccord transparent
- couleur transparente
après séchage

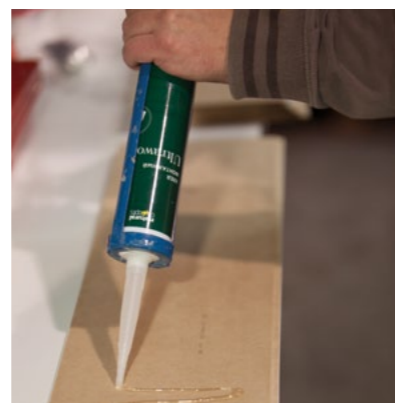

Email : office@ultrawood.eu
www.ultrawood.eu

